



CENNIK DETALICZNY

lato 2010



SOLIDEAL®

OPONY DO WÓZKÓW WIDŁOWYCH

Strony 2 - 20

Superelastyczne

Pneumatyczne

Opaski amortyzujące

OPONY DO MASZYN BUDOWLANYCH

Strony 21 - 31

Miniładowarki

MPT Wielozadaniowe

Koparko-ładowarki

Koparki kołowe

Równiarki

Ładowarki

Walce ogumione

GĄSIENICE GUMOWE

Strony 32 - 43

Budowlane

OTT do miniładowarek

Rolnicze

FELGI I KOMPONENTY

Strony 44 - 51

Przemysłowe

- Karta techniczna felgi

USŁUGI

Strony 52 - 55

- Wypełnienie
- Montaż opon przemysłowych

INFORMACJE DODATKOWE

Strony 56 - 60

- Zamówienie
- Reklamacja
- Informacja/kontakt



Solideal MAGNUM



MAGNUM NM szara MAGNUM NM biała MAGNUM NM

Rozmiar opony	Szerokość felgi	Bieżnik	Cena detaliczna zł netto/szt	Cena detaliczna zł netto/szt (Quick)
3.00 - 4	2.10	MAGNUM	113,00	
	2.50	MAGNUM	116,00	
4.00 - 4	2.10	MAGNUM	250,00	
	2.50	MAGNUM	263,00	
4.00 - 8 (4.80 - 8)	3.00	MAGNUM	386,00	405,30
5.00 - 8	3.00	MAGNUM	480,00	502,95
	3.25	MAGNUM	512,00	
15 x 4.5 - 8 (125 / 75 - 8)	3.00	MAGNUM	321,00	337,05
	3.25	MAGNUM	334,00	
16 x 6 - 8 (150 / 75 - 8)	4.33	MAGNUM	481,00	504,00
18 x 7 - 8 (180 / 75 - 8)	4.33	MAGNUM	562,00	590,10
5.00 - 9	3.50	MAGNUM	657,00	
6.00 - 9 (6.90 - 9)	4.00	MAGNUM	701,00	735,00
21 x 8 - 9 (200 / 75 - 9)	6.00	MAGNUM	824,00	864,15
140/55 - 9 (15 x 5,5 - 9)	4.00	MAGNUM		573,00
6.50 - 10	5.00	MAGNUM	915,00	960,75
7.50 - 10	5.00	MAGNUM	1 232,00	1 293,60
	5.50	MAGNUM	1 232,00	1 293,60
23 x 9 - 10 (225 / 75 - 10)	6.50	MAGNUM	1 114,00	1 169,70
200/50 - 10	6.50	MAGNUM	726,00	762,30
7.00 - 12	5.00	MAGNUM	1 198,00	1 256,85
8.25 - 12	5.00	MAGNUM	1 989,00	
23 x 10 - 12 (250 / 55 - 12)	8.00	MAGNUM	1 264,00	1 326,15
27 x 10 - 12 (250 / 75 - 12)	8.00	MAGNUM	1 662,00	1 745,10
23 x 12 - 12	10.00	MAGNUM	1 971,00	2 163,00
150/100 - 13 (23 x 5)	3.75	MAGNUM	992,00	1 041,60

Wersje / mieszanki za dopłatą:

ELCON +10%
SRS + 10%
ECR+ +10%

NON-MARKING (WHITE) +45%
NON-MARKING (GREY) +35%
WET GRIP +25%

WET GRIP NM (WHITE) +60%
WET GRIP NM (GREY) +50%



Solideal MAGNUM



MAGNUM NM szara MAGNUM NM biała MAGNUM NM

Rozmiar opony	Szerokość felgi	Bieżnik	Cena detaliczna zł netto/szt	Cena detaliczna zł netto/szt (Quick)
6.00 - 15	4.50	MAGNUM	1 394,00	
7.00 - 15	5.50	MAGNUM	1 448,00	1 519,35
7.50 - 15 (30)	5.50	MAGNUM	1 861,00	1 954,05
	6.00	MAGNUM	1 877,00	1 969,80
	6.50	MAGNUM	1 877,00	1 969,80
8.25 - 15	5.50	MAGNUM	2 088,00	2 191,35
	6.00	MAGNUM	2 157,00	2 264,85
	6.50	MAGNUM	2 200,00	2 310,00
28 x 9 - 15 (8.15 - 15) (225 / 75 - 15)	7.00	MAGNUM	1 465,00	1 538,25
28 x 12.5 - 15 (355 / 50 - 15)	9.75	MAGNUM	2 556,00	2 683,80
250 - 15 (250 / 70 - 15)	7.00	MAGNUM	1 605,00	1 684,20
	7.50	MAGNUM	1 636,00	1 716,75
300 - 15 (315 / 70 - 15)	8.00	MAGNUM	2 754,00	2 891,70
310 - 15 EW	8.00	MAGNUM	2 948,00	
355/50 - 15	9,75	MAGNUM	2 556,00	3 405,15
355/65 - 15 (32 x 12.1 - 15)	9,75	MAGNUM	3 244,00	
10.00 - 20	6.50	MAGNUM	4 321,00	
	7.00	MAGNUM	4 321,00	4 536,00
	7.50	MAGNUM	4 321,00	4 536,00
	8.00	MAGNUM	4 321,00	5 213,25
11.00 - 20	8.00	MAGNUM	4 965,00	
12.00 - 20	8.00	MAGNUM	5 019,00	5 269,95
	8.50	MAGNUM	5 019,00	
	10.00	MAGNUM SEMI-TRACK	8 103,00	
14.00 - 24	10.00	MAGNUM	12 217,00	
14.00 - 25	11.25	MAGNUM	13 079,00	
16.00 - 25	11.25	MAGNUM	16 454,00	16 454,00

Wersje / mieszanki za dopłatą:

ELCON +10%
SRS + 10%
ECR+ +10%

NON-MARKING (WHITE) +45%
NON-MARKING (GREY) +35%
WET GRIP +25%

WET GRIP NM (WHITE) +60%
WET GRIP NM (GREY) +50%



Solideal MAGNUM 2



MAG 2

SOLIDAIR LT

SOLIDAIR SKS

Rozmiar opony	Szerokość felgi	Bieżnik	Cena detaliczna zł netto/szt	Cena detaliczna zł netto/szt (Quick)
5.00 - 8	3.00	MAG2	488,00	512,40
15 x 4.5 - 8 (125/75 - 8)	3.00	MAG2	327,00	343,35
18 x 7 - 8(180/70 - 8)	4.33	MAG2	573,00	601,65
6.00 - 9	4.00	MAG2	714,00	749,70
140/55 - 9 (15x5.5 - 9)	4.00	MAG2	w przygotowaniu	w przygotowaniu
6.50 - 10	5.00	MAG2	933,00	979,65
23 x 9 - 10 (225/75-10)	6.50	MAG2	1 136,00	1 192,80
200/50 - 10	6.50	MAG2	w przygotowaniu	w przygotowaniu
7.00 - 12	5.00	MAG2	1 220,00	1 281,00
27 x 10 - 12 (250/75 - 12)	8.00	MAG2	1 695,00	1 779,75
8.25 - 15	6.50	MAG2	2244,00	2 356,20
28 x 12.5 - 15 (355/45 - 15)	9.75	MAG2	2 607,00	2 737,35

MAGNUM air ride

Rozmiar opony	Szerokość felgi	Bieżnik	Cena detaliczna zł netto/szt	Cena detaliczna zł netto/szt (Quick)
5.00 - 8	3.00	Magnum Solid Air LT	502,00	527,10
6.00 - 9	4.00	Magnum Solid Air LT	735,00	771,75
6.50 - 10	5.00	Magnum Solid Air LT	960,00	1 008,00
7.00 - 12	5.00	Magnum Solid Air LT	1 256,00	1 318,80
28 x 9 - 15	7.00	Magnum Solid Air LT	1538,00	1 614,90

Solideal air ride

Rozmiar opony	Szerokość felgi	Bieżnik	Cena detaliczna zł netto/szt	Cena detaliczna zł netto/szt (Quick)
31 x 10 - 20	7.50	Smooth		1 983,00
	7.50	SKS (Left/Right)		1 889,00
33 x 12 - 20	7.50	Smooth		2 744,00
	7.50	SKS (Left/Right)		2 612,00
36 x 14 - 20	7.50	Smooth		3 968,00
	7.50	SKS (Left/Right)		3 779,00

Wersje / mieszanki za dopłatą:

SRS + 10%

ECR+ +10%

WET GRIP +25%

NON-MARKING (WHITE) +45%

NON-MARKING (GREY) +35%

ELCON +10%

WET GRIP NM (WHITE) +60%

WET GRIP NM (GREY) +50%

QUICK + 5%



Solideal HT/SM/RIB/LUG/MIL



HT NM szara HT NM biała HT SM RIB LUG MIL

Rozmiar opony	Szerokość felgi	Bieżnik	Cena detaliczna zł netto/szt	Cena detaliczna zł netto/szt (Quick)
4.00 - 4	2.10	MIL	233,00	
	2.50	MIL	237,00	
3.00 - 5	2.15	LUG	154,00	
3.50 - 5	3.00	LUG	185,00	
140 / 55 - 6	4.50	RIB	272,00	
4.00 x 8 (4.80 - 8)	2.50	HT	293,00	
	2.50	RIB	336,00	
	3.00	HT	355,00	372,75
	3.00	RIB	350,00	
	3.25	HT	341,00	
	3.75	RIB	350,00	
5.00 - 8	3.00	HT	414,00	434,70
	3.00	SM	443,00	465,15
	3.25	HT	440,00	
	3.25	SM	458,00	
	3.75	RIB	458,00	
15 x 4.5 - 8 (125 / 75 - 8)	3.00	HT	295,00	309,75
	3.00	RIB	292,00	306,60
	3.00	SM	314,00	329,70
	3.25	HT	307,00	
	3.25	RIB	305,00	
	3.25	SM	321,00	
16 x 6 - 8 (150 / 75 - 8)	4.33	HT	432,00	453,60
	4.33	SM	464,00	487,20
17 x 7 - 8	4.33	SM	585,00	614,25
18 x 7 - 8 (180 / 70 - 8)	4.33	HT	512,00	537,60
	4.33	SM	554,00	581,70
18 x 9 - 8	7.00	HT	795,00	
	7.00	SM	838,00	
100 / 50 - 8	2.50	SM	191,00	
	3.00	SM	200,00	
18 x 6 - 9	4.00	SM	593,00	622,65
6.00 - 9 (6.90 - 9)	4.00	HT	631,00	662,55
	4.00	RIB	675,00	708,75
	4.00	SM	675,00	708,75

Wersje / mieszanki za dopłatą:

ELCON +10%
SRS + 10%
ECR+ +10%

NON-MARKING (WHITE) +45%
NON-MARKING (GREY) +35%
WET GRIP +25%

WET GRIP NM (WHITE) +60%
WET GRIP NM (GREY) +50%



Solideal HT/SM/RIB



HT NM
szara

HT NM
biała

HT

SM

RIB

Rozmiar opony	Szerokość felgi	Bieżnik	Cena detaliczna zł netto/szt	Cena detaliczna zł netto/szt (Quick)
16 x 5 - 9	3.50	RIB	381,00	400,05
	4.00	RIB	399,00	
21 x 8 - 9 (200 / 75 - 9)	6.00	HT	755,00	792,75
	7.00	HT	814,00	
21 x 7 - 10	5.00	SM	893,00	937,65
6.50 - 10	5.00	HT	824,00	865,20
	5.00	SM	906,00	951,30
	5.50	HT	890,00	
	5.50	SM	934,00	
7.50 - 10	5.00	HT	1 133,00	
	5.50	HT	1 133,00	
23 x 9 - 10 (225 / 75 - 10)	6.50	HT	1 024,00	1 075,20
200/50 - 10	6.50	HT	667,00	700,35
180 / 60 - 10	5.00	RIB	737,00	
7.00 - 12	5.00	HT	1 082,00	1 136,10
	5.00	SM	1 187,00	1 246,35
23 x 10 - 12 (250 / 55 - 12)	8.00	HT	1 130,00	1 186,50
27 x 10 - 12 (250 / 75 - 12)	8.00	HT	1 529,00	1 605,45
	8.00	SM	2 258,00	2 370,90
8.25 - 12	5.50	SM	2 137,00	
5.50 - 15	4.50	HT	926,00	
7.00 - 15	5.50	HT	1 331,00	
	6.00	HT	1 432,00	
7.50 - 15 (30)	5.50	HT	1 712,00	1 797,60
	6.00	HT	1 725,00	
	6.50	HT	1 725,00	1 811,25
8.25 - 15	5.50	HT	1 920,00	
	5.50	SM	2 167,00	
	6.00	HT	1 984,00	
	6.00	SM	2 234,00	
	6.50	HT	2 024,00	2 125,20
	6.50	SM	2 234,00	2 345,70
28 x 9 - 15 (8.15 - 15) (225 / 75 - 15)	6.50	HT	1 421,00	
	7.00	HT	1 347,00	1 414,35
28 x 12.5 - 15 (355 / 45 - 15)	9.75	HT	2 351,00	2 468,55

Wersje / mieszanki za dopłatą:

ELCON +10%
SRS + 10%
ECR+ +10%

NON-MARKING (WHITE) +45%
NON-MARKING (GREY) +35%
WET GRIP +25%

WET GRIP NM (WHITE) +60%
WET GRIP NM (GREY) +50%



Solideal HT/SM/SKS



HT NM
szara

HT NM
biała

HT

SM

SKS
Safetymaster

Rozmiar opony	Szerokość felgi	Bieżnik	Cena detaliczna zł netto/szt	Cena detaliczna zł netto/szt (Quick)
250 x 15 (250 / 70 - 15)	7.00	HT	1 475,00	1 548,75
	7.50	HT	1 504,00	
300 x 15 (300 / 70 - 15)	8.00	HT	2 533,00	2 659,65
	8.00	SM	2 777,00	2 915,85
355/65 - 15 (32 x 12.1 - 15)	9.75	HT	2 983,00	3 132,15
680 / 180 - 15	5.50 / (5.00)	ECOMATIC	1 537,00	
6.50 - 16	5.50	HT	2 158,00	
	5.50	SM	2 268,00	
	5.50	SKS (Left/Right)	2 159,00	2 266,95
7.50 - 16	6.00	HT	2 202,00	
	5.50	HT	2 250,00	2 362,50
	5.50	SKS (Left/Right)	2 251,00	2 363,55
	6.00	HT	2 294,00	
8.00 - 16	6.00	SKS	2 295,00	
	5.50	SKS (Left/Right)	2 317,00	2 432,85
	6.00	SKS	2 363,00	
9.00 - 16	5.50	SKS (Left/Right)	2 451,00	2 573,55
	6.00	SKS	2 522,00	
7.50 - 20	6.00	HT	2 671,00	
	6.50	HT	2 752,00	
8.25 - 20	6.50	HT	2 671,00	
	6.50	SM	2 807,00	
	7.00	HT	2 806,00	
	7.00	SM	2 945,00	
	7.50	HT	2 970,00	
	7.50	SM	3 034,00	

Wersje / mieszanki za dopłatą:

ELCON +10%
SRS + 10%
ECR+ +10%

NON-MARKING (WHITE) +45%
NON-MARKING (GREY) +35%
WET GRIP +25%

WET GRIP NM (WHITE) +60%
WET GRIP NM (GREY) +50%



Solideal HT/SM/SKS



HT NM szara HT NM biała HT SM SKS Safetymaster

Rozmiar opony	Szerokość felgi	Bieżnik	Cena detaliczna zł netto/szt	Cena detaliczna zł netto/szt (Quick)
9.00 - 20	6.50	HT	3 382,00	
	7.00	HT	3 382,00	
	7.50	HT	3 450,00	
10.00 - 20	7.00	HT	3 974,00	
	7.00	SM	4 487,00	
	7.50	HT	4 158,00	
	7.50	SM	4 487,00	
	8.00	HT	3 974,00	
	8.00	SM	4 487,00	
12.00 - 20	8.00	HT	4 617,00	
	8.00	SM	5 213,00	
	8.50	HT	4 617,00	
	8.50	SM	5 213,00	
	10.00	SM	5 234,00	
31 x 10 - 20	7.50	SM	1 800,00	1 890,00
	7.50	SKS (Left/Right)	1 715,00	1 800,75
33 x 12 - 20	7.50	SM	2 489,00	2 613,45
	7.50	SKS (Left/Right)	2 371,00	2 489,55
36 x 14 - 20	7.50	SM	3 600,00	3 780,00
	7.50	SKS (Left/Right)	3 429,00	3 600,45
12.00 - 24	8.00 TG	HT	5 551,00	
	8.50	HT	5 551,00	
	10.00	SM	8 916,00	
14.00 - 24	10.00	HT	11 238,00	
355/85 - 24 (48.5 x 14 - 24)	11.25	SM	11 579,00	
	12.00	SM	12 736,00	
16.00 - 25	11.25	SKS	17 858,00	

Wersje / mieszanki za dopłatą:

ELCON +10% NON-MARKING (WHITE) +45% WET GRIP NM (WHITE) +60%
 SRS + 10% NON-MARKING (GREY) +35% WET GRIP NM (GREY) +50%
 ECR+ +10% WET GRIP +25%



Armordilo TR



ARMORDILO TR

Rozmiar opony	Szerokość felgi	Bieżnik	Cena detaliczna zł netto/szt	Cena detaliczna zł netto/szt (Quick)
5.00 - 8	3.00	TR	372,00	390,60
15 x 4.5 - 8 (125 / 75 - 8)	3.00	TR	257,00	269,85
16 x 6 - 8 (150 / 75 - 8)	4.33	TR	384,00	403,20
18 x 7 - 8 (180 / 70 - 8)	4.33	TR	450,00	472,50
6.00 - 9 (6.90 - 9)	4.00	TR	549,00	576,45
21 x 8 - 9 (225 / 75 - 9)	6.00	TR	658,00	690,90
6.50 - 10	5.00	TR	718,00	753,90
23 x 9 - 10 (225 / 75 - 9)	6.50	TR	891,00	935,55
7.00 - 12	5.00	TR	940,00	987,00
27 x 10 - 12 (225 / 75 - 10)	8.00	TR	1 309,00	1 374,45
7.00 - 15	5.50	TR	1 168,00	
	6.00	TR	1 168,00	
7.50 - 15	6.50	TR	1 516,00	1 591,80
8.25 - 15	6.50	TR	1 774,00	1 862,70
28 x 9 - 15 (8.15 - 15) (225 / 75 - 15)	7.00	TR	1 182,00	1 241,10
28 x 12.5 - 15 (355 / 50 - 15)	9.75	TR	2 045,00	2 147,25
250 - 15 (250 / 70 - 15)	7.00	TR	1 245,00	1 307,25
	7.50	TR	1 319,00	
300 - 15 (300 / 70 - 15)	8.00	TR	2 188,00	2 297,40
355/65 - 15 (32 x 12.1 - 15)	9.75	TR	2 646,00	2 778,30
10.00 - 20	7.50	TR	3 518,00	
	8.00	TR	3 544,00	

UWAGA: Opony marki Armordilo TR są niedostępne w wersji Non marking.



Solideal ED (Extra Deep)



ED NM
szara

ED

Rozmiar opony	Liczba PR	Bieżnik	Dętka	Cena detaliczna zł netto/kpl
4.00 - 8 (4.80 - 8)	6	Extra Deep	TT	182,00
	8	Extra Deep	TT	187,00
	10	Extra Deep	TT	194,00
5.00 - 8	6	Extra Deep	TT	199,00
	8	Extra Deep	TT	207,00
	10	Extra Deep	TT	215,00
18 x 7 - 8 (180 / 70 - 8)	14	Extra Deep	TT	312,00
	16	Extra Deep	TT	333,00
6.00 - 9 (6.90 - 9)	10	Extra Deep	TT	294,00
	12	Extra Deep	TT	308,00
21 x 8 - 9 (200 / 75 - 9)	14	Extra Deep	TT	464,00
	16	Extra Deep	TT	492,00
6.50 - 10	10	Extra Deep	TT	368,00
	12	Extra Deep	TT	382,00
	14	Extra Deep	TT	389,00
7.50 - 10	12	Extra Deep	TT	594,00
	16	Extra Deep	TT	639,00
23 x 9 - 10 (225 / 75 - 10)	14	Extra Deep	TT	645,00
	16	Extra Deep	TT	676,00
	18	Extra Deep	TT	708,00
7.00 - 12	12	Extra Deep	TT	463,00
	14	Extra Deep	TT	506,00
	16	Extra Deep	TT	552,00

UWAGA:

Opony SOLIDEAL ED sprzedawane są w komplecie (opona + dętka + ochraniacz)

Wersje / mieszanki za dopłatą:

ECR+ +10%

NON-MARKING (GREY) +50%

ELCON +10%



Solideal ED (Extra Deep)



ED NM
szara

ED

Rozmiar opony	Liczba PR	Bieżnik	Dętka	Cena detaliczna zł netto/kpl
23 x 10 - 12 (250 / 55 - 10)	14	Extra Deep	TT	627,00
	16	Extra Deep	TT	683,00
27 x 10 - 12 (250 / 75 - 12)	14	Extra Deep	TT	906,00
	16	Extra Deep	TT	943,00
	20	Extra Deep	TT	1 027,00
23 x 5 (150 / 100 - 13)	6	Extra Deep	TT	348,00
	8	Extra Deep	TT	357,00
	10	Extra Deep	TT	371,00
7.00 - 15	10	Extra Deep	TT	636,00
	12	Extra Deep	TT	674,00
	14	Extra Deep	TT	705,00
7.50 - 15	10	Extra Deep	TT	690,00
	12	Extra Deep	TT	720,00
	14	Extra Deep	TT	749,00
	16	Extra Deep	TT	795,00
8.25 - 15	12	Extra Deep	TT	973,00
	14	Extra Deep	TT	992,00
	16	Extra Deep	TT	1 073,00
28 x 9 - 15 (8.15 - 15) (225 / 75 - 15)	12	Extra Deep	TT	803,00
	14	Extra Deep	TT	834,00
	16	Extra Deep	TT	869,00
250 - 15 (250 / 70 - 15)	16	Extra Deep	TT	988,00
	18	Extra Deep	TT	1 005,00
	20	Extra Deep	TT	1 057,00
300 - 15 (315 / 70 - 15)	18	Extra Deep	TT	1 422,00
	20	Extra Deep	TT	1 493,00
7.50 - 16	12	Extra Deep	TT	1 093,00
9.00 - 20	14	Extra Deep	TT	1 696,00
10.00 - 20	16	Extra Deep	TT	1 775,00

UWAGA:

Opony SOLIDEAL ED sprzedawane są w komplecie (opona + dętka + ochraniacz)

Wersje / mieszanki za dopłatą:

ECR+ +10%

NON-MARKING (GREY) +50%

ELCON +10%



Solideal RIB LUG



RIB LUG

Rozmiar opony	Liczba PR	Bieżnik	Dętka	Cena detaliczna zł netto/kpl
15 x 4,5 - 8 (125 / 75 - 8)	12	RIB LUG	TT	199,00
5.00 - 8	8	RIB LUG	TT	191,00
	10	RIB LUG	TT	198,00
16 x 6 - 8 (150 / 75 - 8)	10	RIB LUG	TT	198,00
18 x 7 - 8 (180 / 70 - 8)	14	RIB LUG	TT	287,00
6.00 - 9 (6.90 - 9)	10	RIB LUG	TT	272,00
21 x 8 - 9 (200 / 75 - 9)	14	RIB LUG	TT	418,00
	16	RIB LUG	TT	437,00
6.50 - 10	10	RIB LUG	TT	335,00
23 x 9 - 10 (225 / 75 - 10)	16	RIB LUG	TT	650,00
	20	RIB LUG	TT	715,00
28 x 9 - 15 (8.15 - 15) (225 / 75 - 15)	14	RIB LUG	TT	734,00
	16	RIB LUG	TT	772,00

UWAGA:

Opony SOLIDEAL RIB LUG sprzedawane są w komplecie (opona + dętka + ochraniacz)



RIB

ZZ RIB

Solideal RIB/ZZ RIB

Rozmiar opony	Liczba PR	Bieżnik	Dętka	Cena detaliczna zł netto/szt
4.00 x 8 (4.80 x 8)	6	RIB	TT/TBLS	187,00
	8	RIB	TT/TBLS	196,00
6.90 x 9 (6.00 - 9)	6	ZZ RIB	TT/TBLS	491,00
	8	ZZ RIB	TT/TBLS	518,00
	10	ZZ RIB	TT/TBLS	552,00
6.50 - 10	10	ZZ RIB	TT	553,00
8.00 - 16.5	8	ZZ RIB	TT	1 020,00

Wersje / mieszanki za dopłatą:

ECR+ +10%

ELCON +10%

NON-MARKING (GREY) +50%



HAULER LT



LT

Rozmiar opony	Liczba PR	Bieżnik	Dętka	Cena detaliczna zł netto/kpl
5.00 - 8	10	Liftruck Traction	TT	280,00
16 x 6 - 8 (150 / 75 - 8)	14	Liftruck Traction	TT	327,00
	16	Liftruck Traction	TT	348,00
18 x 7 - 8 (180 / 70 - 8)	8	Liftruck Traction	TT	360,00
	10	Liftruck Traction	TT	369,00
	14	Liftruck Traction	TT	379,00
	16	Liftruck Traction	TT	389,00
	18	Liftruck Traction	TT	412,00
6.00 - 9 (6.90 - 9)	10	Liftruck Traction	TT	409,00
	12	Liftruck Traction	TT	423,00
21 x 8 - 9 (200 / 75 - 9)	16	Liftruck Traction	TT	586,00
6.50 - 10	10	Liftruck Traction	TT	489,00
	12	Liftruck Traction	TT	513,00
	14	Liftruck Traction	TT	540,00
23 x 9 - 10 (225 / 75 - 10)	18	Liftruck Traction	TT	855,00
	20	Liftruck Traction	TT	900,00
7.00 - 12	10	Liftruck Traction	TT	580,00
	12	Liftruck Traction	TT	623,00
	14	Liftruck Traction	TT	649,00
	16	Liftruck Traction	TT	674,00
23 x 10 - 12 (250 / 55 - 12)	8	Liftruck Traction	TT	762,00
	12	Liftruck Traction	TT	848,00
	16	Liftruck Traction	TT	940,00
27 x 10 - 12 (250 / 75 - 12)	14	Liftruck Traction	TT	964,00
	16	Liftruck Traction	TT	1 005,00
	20	Liftruck Traction	TT	1 073,00
	24	Liftruck Traction	TT	1 169,00
7.00 - 15	14	Liftruck Traction	TT	822,00
7.50 - 15	14	Liftruck Traction	TT	1 073,00

UWAGA:

Opony HAULER LT sprzedawane są w komplecie (opona + dętka + ochraniacz)

Wersje / mieszanki za dopłatą:

ECR+ +10%

NON-MARKING (GREY) +50%

ELCON +10%



HAULER LT/SM/1 L/ HA-TR /HD Portmaster



Rozmiar opony	Liczba PR	Bieżnik	Dętka	Cena detaliczna zł netto/kpl
8.25 - 15	14	Liftruck Traction	TT	1 199,00
	16	Liftruck Traction	TT	1 257,00
	16	Liftruck Half Track	TT	1 383,00
	16	Liftruck Smooth	TT	1 454,00
	18	Liftruck Traction	TT	1 358,00
	20	Liftruck Smooth	TT	1 472,00
28 x 9 - 15 (8.15 - 15) (225 / 75 - 15)	14	Liftruck Traction	TT	955,00
	16	Liftruck Traction	TT	1 003,00
250 - 15 (250 / 70 - 15)	16	Liftruck Traction	TT	1 391,00
	18	Liftruck Traction	TT	1 442,00
	20	Liftruck Traction	TT	1 476,00
290 - 15	20	Liftruck Traction	TT	1 820,00
300 - 15 (300 / 70 - 15)	18	Liftruck Traction	TT	1 661,00
	20	Liftruck Traction	TT	1 749,00
	22	Liftruck Traction	TT	1 888,00
28 x 12.5 - 15 (355 / 45 - 15)	24	Liftruck Traction	TT	1 493,00
32 x 12.1 - 15 (355 / 65 - 15)	24	Liftruck Traction	TT	2 648,00
9.00 - 20	14	Liftruck Traction	TT	w przygotowaniu
	16	Liftruck Traction	TT	w przygotowaniu
10.00 - 20 (290 / 95 - 20)	16	Liftruck Traction	TT	2 624,00
	16	Liftruck Half Track	TT	2 757,00
	16	Liftruck Smooth	TT	2 757,00
	18	Liftruck Traction	TT	2 939,00
	20	Liftruck Smooth	TT	3 085,00
	20	Liftruck Traction	TT	3 085,00
11.00 - 20 (300 / 95 - 20)	16	Liftruck Traction	TT	2 831,00
	18	Liftruck Traction	TT	2 931,00
12.00 - 20 (330 / 95 - 20)	18	Liftruck Traction	TT	3 062,00
	20	Liftruck Traction	TT	3 224,00
	20	Liftruck Half Track	TT	3 569,00
	20	Liftruck Smooth 1 LUG	TT	3 608,00
	20	Liftruck Smooth	TT	3 566,00
	20	Liftruck Heavy Duty Portmaster	TT	4 029,00
	28	Liftruck Traction	TT	3 975,00
	28	Liftruck Heavy Duty Portmaster	TT	4 768,00
14.00 - 24	28	Liftruck Traction	TL/TT	6 344,00
16.00 - 25	32	Liftruck Traction	TL/TT	9 790,00

UWAGA:

Opony HAULER LT/SM/1L/HA-TR/HD portmaster sprzedawane są w komplecie (opona + dętka + ochraniacz)

Wersje / mieszanki za dopłatą:

ECR+ +10%

ELCON +10%

NON-MARKING (GREY) +50%



Rozmiar dętki	Zawór			Cena detaliczna zł netto/szt
15 x 4,5 - 8	JS2			34,00
4.00 - 8	JS2			34,00
5.00 - 8	JS2			45,00
16 x 6 - 8	V3-02-05			49,00
18 x 7 - 8	V3-02-05			61,00
6.00 - 9	JS2			53,00
21 x 8 - 9	JS2			55,00
6.50 - 10	JS2			67,00
7.50 - 10	JS2			65,00
23 x 9 - 10	JS2			61,00
7.00 - 12	TR75A			74,00
8.25 - 12	V3-02-09			na zamówienie
23 x 10 - 12	JS2			78,00
27 x 10 - 12	JS2			113,00
23 - 5	JS2			53,00
7.00 - 15	TR75A			83,00
7.50 - 15	TR75A			83,00
8.15 - 15	V3-02-09			102,00
8.25 - 15	TR77A			126,00
250 - 15	TR77A			105,00
300 - 15	TR78A			103,00
28 x 12.5 - 15	V3-02-11			139,00
32 x 12.1 - 15	TR78A			126,00
7.50 - 16	TR75A			85,00
8.25 / 9.00 - 20	V3-02-14			98,00
10.00 / 11.00 - 20	V3-02-14			186,00
12.00 - 20	V3-02-14			224,00

Rozmiar dętki	Zawór			Cena detaliczna zł netto/szt
5.70 - 12	TR13			40,00
23 x 8.5 - 12	TR13			67,00
27 x 8.5 - 15	TR15			73,00
10-x 16.5	TR15			83,00
12 - 16.5	TR15			126,00

Rozmiar ochraniacza		Cena detaliczna zł netto/szt
90 x 8	(4.00 - 8 / 15 x 4,5 - 8 / 5.00 - 8)	10,00
130 x 8	(16 x 6 - 8 / 18 x 7 - 8)	27,00
125 x 9	(6.00 - 9 / 6.90 - 9)	15,00
180 x 9	(21 x 8 - 9)	32,00
140 x 10	(6.50 - 10 / 7.50 - 10 / 9.00 - 10)	15,00
180 x 10	(23 x 9 - 10)	27,00
135 x 12	(7.00 - 12 / 8.25 - 12)	21,00
210 x 12	(23 x 10 - 12 / 27 x 10 - 12)	21,00
130 x 13	(23 - 5)	27,00
180 x 15	(7.00 - 15 / 7.50 - 15 / 8.25 - 15)	35,00
180 x 15 HD	(28 x 9 - 15 / 250 - 15 / 290 - 15 / 300 - 15)	32,00
260 x 15	(28 x 12,5 - 15 / 32 x 12,1 - 15)	55,00
180 x 16	(7.50 - 16)	40,00
200 x 20	(8.25 - 20 / 9.00 - 20 / 10.00 - 20 / 11.00 - 20 / 12.00 - 20)	58,00



Solideal SM/HT



SM

HT NM
biała

HT

Rozmiar opony		Bieżnik		Cena detaliczna zł netto/szt
8 1/2 x 4 x 4		SM		254,00
9 x 5 x 5		SM		280,00
10 x 4 x 6 1/4		SM		286,00
10 x 5 x 6 1/4		SM		297,00
10 x 6 x 6 1/4		SM		308,00
10 x 4 x 6 1/2		SM		291,00
10 x 5 x 6 1/2		SM		297,00
10 1/2 x 5 x 6 1/2		SM		300,00
10 1/2 x 6 x 6 1/2		SM		316,00
10 1/2 x 7 x 6 1/2		SM		332,00
12 x 4 x 8		SM		237,00
12 x 4 1/2 x 8		SM		231,00
12 x 5 x 8		SM		260,00
12 x 5 1/2 x 8		SM		287,00
12 x 6 1/2 x 8		SM		354,00
13 x 3 1/2 x 8		SM		288,00
13 x 3 1/2 x 8		HT		288,00
13 x 4 1/2 x 8		SM		346,00
13 x 4 1/2 x 8		HT		346,00
13 x 5 x 8		HT		332,00
13 1/2 x 4 1/2 x 8		SM		353,00
13 1/2 x 5 1/2 x 8		SM		408,00
13 1/2 x 5 1/2 x 8		HT		408,00
14 x 4 1/2 x 8		SM		375,00
14 x 4 1/2 x 8		HT		375,00
14 x 5 x 10		SM		398,00
15 1/2 x 5 x 10		SM		430,00
15 1/2 x 5 x 10		HT		430,00
15 1/2 x 6 x 10		SM		514,00
16 x 5 x 10 1/2		SM		446,00
16 x 5 x 10 1/2		HT		446,00
16 x 6 x 10 1/2		SM		507,00
16 x 6 x 10 1/2		HT		507,00
16 x 7 x 10 1/2		SM		603,00
16 x 7 x 10 1/2		HT		603,00

Wersje / mieszanki za dopłatą:

SRP +10%,
High Load (HL) + 25%

NON-MARKING (WHITE) +45%
NON-MARKING (GREY) +35%

WET GRIP NM (WHITE) +60%
WET GRIP NM (GREY) +50%

WET GRIP +25%
ELCON +10%



Solideal SM/HT



SM

HT NM
biała

HT

Rozmiar opony		Bieżnik		Cena detaliczna zł netto/szt
15 x 4 x 11 1/4		SM		320,00
15 x 5 x 11 1/4		SM		336,00
		HT		336,00
15 x 6 x 11 1/4		SM		408,00
16 1/4 x 5 x 11 1/4		SM		414,00
		HT		414,00
16 1/4 x 6 x 11 1/4		SM		464,00
		HT		464,00
16 1/4 x 7 x 11 1/4		SM		554,00
16 1/4 x 8 x 11 1/4		SM		638,00
17 x 5 x 12 1/8		SM		449,00
17 x 6 x 12 1/8		SM		518,00
		HT		518,00
18 x 5 x 12 1/8		SM		492,00
		HT		492,00
18 x 6 x 12 1/8		SM		542,00
		HT		542,00
18 x 7 x 12 1/8		SM		655,00
		HT		655,00
18 x 8 x 12 1/8		SM		748,00
		HT		748,00
18 x 9 x 12 1/8		SM		799,00
		HT		799,00
20 x 8 x 15		SM		801,00
20 x 9 x 15		SM		920,00
21 x 5 x 15		HT		564,00
21 x 6 x 15		HT		657,00
21 x 7 x 15		SM		766,00
		HT		766,00
21 x 8 x 15		SM		883,00
		HT		883,00
21 x 9 x 15		SM		1 002,00
		HT		1 002,00

Wersje / mieszanki za dopłatą:

SRP +10%,
High Load (HL) + 25%

NON-MARKING (WHITE) +45%
NON-MARKING (GREY) +35%

WET GRIP NM (WHITE) +60%
WET GRIP NM (GREY) +50%

WET GRIP +25%
ELCON +10%



Solideal SM/HT/LUG



SM

HT NM
biała

HT

LUG

Rozmiar opony		Bieżnik		Cena detaliczna zł netto/szt
20 x 8 x 16		SM		726,00
		HT		726,00
20 x 9 x 16		SM		818,00
22 x 6 x 16		SM		705,00
		HT		705,00
22 x 7 x 16		SM		822,00
		HT		822,00
22 x 8 x 16		SM		926,00
		HT		926,00
22 x 9 x 16		SM		1 041,00
		HT		1 041,00
22 x 10 x 16		SM		1 252,00
22 x 12 x 16		SM		1 483,00
22 x 14 x 16		SM		1 623,00
		LUG		1 623,00
22 x 16 x 16		SM		1 868,00
20 1/2 x 7 x 17 3/4		SM		579,00
22 x 6 x 17 3/4		SM		713,00
22 x 7 x 17 3/4		SM		783,00
22 x 8 x 17 3/4		SM		892,00
22 x 12 x 17 3/4		LUG		1 336,00
22 x 14 x 17 3/4		LUG		1 557,00
26 x 6 x 20		SM		906,00
26 x 7 x 20		SM		1 109,00
26 x 8 x 20		SM		na zamówienie
28 x 10 x 22		SM		1 628,00
28 x 12 x 22		SM		2 411,00
		LUG		2 411,00
28 x 14 x 22		SM		2 821,00
28 x 16 x 22		SM		3 080,00
40 x 12 x 30		SM		3 995,00
40 x 14 x 30		SM		4 595,00
40 x 16 x 30		SM		5 336,00
40 x 20 x 30		SM		6 723,00

Wersje / mieszanki za dopłatą:

SRP +10%,
High Load (HL) + 25%

NON-MARKING (WHITE) +45%
NON-MARKING (GREY) +35%

WET GRIP NM (WHITE) +60%
WET GRIP NM (GREY) +50%

WET GRIP +25%
ELCON +10%



Solideal SM/LUG



SM

LUG

Rozmiar opony		Bieżnik		Cena detaliczna zł netto/szt
250 / 75 - 140		SM		154,00
260 / 75 - 140		SM		163,00
250 / 130 - 140		SM		207,00
250 / 80 - 170		SM		198,00
250 / 105 - 170		SM		238,00
330 / 145 - 180		RIB		w przygotowaniu
330 / 145 - 180		SM		w przygotowaniu
265 / 85 - 190 ***		SM		217,00
330 / 145 - 194		SM		w przygotowaniu
300 / 90 - 203		SM		181,00
365 / 160 - 220		SM		331,00
300 / 75 - 240		SM		199,00
380 / 165 - 246		RIB		w przygotowaniu
380 / 165 - 246		SM		w przygotowaniu
360 / 60 - 270		SM		215,00
360 / 85 - 270		SM		224,00
350 / 90 - 280		SM		311,00
405 / 130 - 305		SM		424,00
405 / 260 - 305		SM		823,00
415 / 75 - 305		SM		272,00
415 / 90 - 305		SM		287,00
415 / 100 - 305		SM		311,00
425 / 150 - 305		SM		573,00
425 / 260 - 305		SM		886,00
425 / 300 - 305		SM		975,00
450 / 300 - 305		SM		1 331,00
520 / 120 - 370		SM		503,00
550 / 150 - 370		SM		706,00
540 / 200 - 410		SM		1 064,00
550 / 120 - 410		SM		765,00
550 / 160 - 410		SM		717,00
645 / 220 - 410		SM		1 724,00
645 / 250 - 410		SM		1 871,00
645 / 300 - 410		SM		2 077,00
645 / 350 - 410		SM		2 244,00
660 / 203 - 480		SM		1 197,00
660 / 203 - 480		LUG		1 139,00
660 / 250 - 480		SM		1 571,00
660 / 250 - 480		LUG		1 498,00
660 / 280 - 480		SM		w przygotowaniu
760 / 250 - 500		SM		4 115,00
840 / 350 - 559 ***		SM (MAGNUM)		4 301,00

***- na specjalne zamówienie

Wersje / mieszanki za dopłatą:

SRP +10%,
High Load (HL) + 25%

NON-MARKING (WHITE) +45%
NON-MARKING (GREY) +35%

WET GRIP NM (WHITE) +60%
WET GRIP NM (GREY) +50%

WET GRIP +25%
ELCON +10%



Solideal MAGNUM



MAGNUM NM
biała MAGNUM

Rozmiar opony		Bieżnik		Cena detaliczna zł netto/szt
10 x 5 x 6 1/2		MAG		316,00
13 1/2 x 4 1/2 x 8		MAG		380,00
13 1/2 x 5 1/2 x 8		MAG		438,00
14 x 4 1/2 x 8		MAG		550,00
14 x 5 x 10		MAG		na zamówienie
15 1/2 x 5 x 10		MAG		463,00
16 x 5 x 10 1/2		MAG		482,00
16 x 6 x 10 1/2		MAG		548,00
15 x 5 x 11 1/4		MAG		364,00
16 1/4 x 5 x 11 1/4		MAG		448,00
16 1/4 x 6 x 11 1/4		MAG		500,00
16 1/4 x 7 x 11 1/4		MAG		609,00
17 x 5 x 12 1/8		MAG		482,00
17 x 6 x 12 1/8		MAG		553,00
18 x 5 x 12 1/8		MAG		533,00
18 x 6 x 12 1/8		MAG		586,00
18 x 7 x 12 1/8		MAG		708,00
18 x 8 x 12 1/8		MAG		808,00
18 x 9 x 12 1/8		MAG		863,00
21 x 6 x 15		MAG		722,00
21 x 7 x 15		MAG		827,00
21 x 8 x 15		MAG		953,00
21 x 9 x 15		MAG		1 082,00
22 x 6 x 16		MAG		760,00
22 x 7 x 16		MAG		881,00
22 x 8 x 16		MAG		1 002,00
22 x 9 x 16		MAG		1 125,00
22 x 10 x 16		MAG		1 351,00
22 x 12 x 16		MAG		1 603,00
28 x 12 x 22		MAG		2 604,00

Wersje / mieszanki za dopłatą:

SRP +10%,
High Load (HL) + 25%

NON-MARKING (WHITE) +45%
NON-MARKING (GREY) +35%

WET GRIP NM (WHITE) +60%
WET GRIP NM (GREY) +50%

WET GRIP +25%
ELCON +10%



SKS Classic

SKS XTRA

SKS R1
Tractionmaster

Solideal SKS/XTRA Tractionmaster R1

Rozmiar opony	Liczba PR	Bieżnik	Dętka	Cena detaliczna zł netto/szt
5.70 - 12	6	SKS	TBLS	242,00
23 x 8.5 - 12	4	SKS Classic	TBLS	282,00
	4	SKS Xtra	TBLS	312,00
	6	SKS Classic	TBLS	298,00
	6	SKS Xtra	TBLS	312,00
	10	SKS Classic	TBLS	321,00
	10	SKS Xtra	TBLS	335,00
	12	SKS Classic	TBLS	334,00
	12	SKS Xtra	TBLS	352,00
26 x 12 - 12	4	SKS R1 Traction Master	TBLS	633,00
	6	SKS R1 Traction Master	TBLS	652,00
	8	SKS Xtra	TBLS	641,00
	8	SKS R1 Traction Master	TBLS	672,00
	10	SKS Xtra	TBLS	676,00
	10	SKS R1 Traction Master	TBLS	708,00
27 x 10 - 12	14	SKS	TT	863,00
9 - 14.5	12	OTR Wearmaster		609,00
7.00 - 15	6	SKS	TT/TBLS	739,00
27 x 8.5 - 15	6	SKS Classic	TBLS	360,00
	6	SKS Xtra	TBLS	379,00
	8	SKS Classic	TBLS	379,00
	8	SKS Xtra	TBLS	397,00
29 x 12.5 - 15	8	SKS R1 Traction Master	TBLS	685,00
31 x 15.5 - 15	6	SKS R1 Traction Master	TBLS	831,00
	8	SKS	TBLS	891,00
	8	SKS R1 Traction Master	TBLS	936,00
	10	SKS R1 Traction Master	TBLS	984,00
26 x 12 - 16,5 (300/40 - 16.5)	6	SKS R1 LAR Traction Master	TBLS	510,00
	10	SKS R1 LAR Traction Master	TBLS	561,00
	10	SKS R4 LAR	TBLS	639,00

UWAGA:

Rozmiary opon SKS superelastycznych są na stronie 7 i 8.

Wersje / mieszanki za dopłatą:

ECR+ +10%

ELCON +10%

NON-MARKING (GREY) +50%



SKS Classic

SKS XTRA

SKS R1
Tractionmaster

Solideal SKS/XTRA Tractionmaster R1

Rozmiar opony	Liczba PR	Bieżnik	Dętka	Cena detaliczna zł netto/szt
10 - 16.5	6	SKS Classic	TBLS	564,00
	6	SKS Xtra	TBLS	564,00
	8	SKS Classic	TBLS	594,00
	8	SKS Xtra	TBLS	594,00
	10	SKS Classic	TBLS	624,00
	10	SKS Xtra	TBLS	624,00
12 - 16.5	12	SKS Xtra	TBLS	656,00
	8	SKS Classic	TBLS	801,00
	8	SKS Xtra	TBLS	801,00
	10	SKS Classic	TBLS	843,00
	10	SKS Xtra	TBLS	843,00
33 x 15,5 - 16,5	12	SKS Classic	TBLS	884,00
	12	SKS Xtra	TBLS	884,00
14 - 17.5	10	SKS R1 Traction Master	TBLS	1 417,00
	8	SKS Classic	TBLS	1 522,00
	8	SKS Xtra	TBLS	1 536,00
	10	SKS Classic	TBLS	1 568,00
	10	SKS Xtra	TBLS	1 568,00
	12	SKS Classic	TBLS	1 668,00
	12	SKS Xtra	TBLS	1 668,00
	14	SKS Classic	TBLS	1 758,00
14	SKS Xtra	TBLS	1 772,00	

Wersje / mieszanki za dopłatą:

ECR+ +10%

ELCON +10%

NON-MARKING (GREY) +50%



SKS

SKZ
Lifemaster

XD44 L5

Hauler SKS SKZ Lifemaster/XD44L5

Rozmiar opony	Liczba PR	Bieżnik	Dętka	Cena detaliczna zł netto/szt
5.70 - 12	6	SKS	TBLS	290,00
23 x 8.5 - 12	6	SKS	TBLS	391,00
	10	SKS	TBLS	421,00
	12	SKS	TBLS	438,00
	6	SKS	TBLS	471,00
27 x 8.5 - 15	8	SKS	TBLS	495,00
27 x 9.5 - 15	6	SKS	TBLS	493,00
27 x 10.5 - 15	8	SKS	TBLS	515,00
	10	SKS	TBLS	542,00
31 x 15.5 - 15	8	SKZ Lifemaster	TBLS	1 518,00
	8	SKS	TBLS	1 214,00
	10	SKS	TBLS	1 277,00
	12	SKS	TBLS	1 342,00
10 - 16.5 (30)	8	SKS	TBLS	746,00
	10	SKS	TBLS	806,00
10 - 16.5	8	SKS	TBLS	779,00
	8	SKZ Lifemaster	TBLS	1 049,00
	10	SKS	TBLS	844,00
	10	XD44 L5	TBLS	1 268,00
	10	SKZ Lifemaster	TBLS	1 103,00
	12	SKS	TBLS	911,00
31.5 x 13 - 16.5	10	SKS	TBLS	804,00
12 - 16.5	8	SKS	TBLS	1 009,00
	10	SKS	TBLS	1 063,00
	10	SKZ Lifemaster	TBLS	1 258,00
	12	SKS	TBLS	1 148,00
	12	XD44 L5	TBLS	1 448,00
	12	SKZ Lifemaster	TBLS	1 322,00
	14	SKS	TBLS	1 387,00

Wersje / mieszanki za dopłatą:

ECR+ +10%

NON-MARKING (GREY) +50%

ELCON +10%



SKS

SKZ
Lifemaster

Hauler SKS SKZ Lifemaster

Rozmiar opony	Liczba PR	Bieżnik	Dętka	Cena detaliczna zł netto/szt
33 x 15.5 - 16.5	12	SKS	TBLS	1 446,00
	14	SKS	TBLS	1 590,00
	14	SKZ Lifemaster	TBLS	1 875,00
14 - 17.5	10	SKS	TBLS	1 722,00
	10	SKZ Lifemaster	TBLS	2 031,00
	14	SKS	TBLS	1 854,00
	14	SKZ Lifemaster	TBLS	2 190,00
380/65 - 19.5 (14.5 - 19.5)	12	SKS	TBLS	2 073,00
	14	SKS	TBLS	2 256,00
	16	SKS	TBLS	2 436,00
15 - 19.5	8	SKS	TBLS	1 930,00
	10	SKS	TBLS	2 099,00
	12	SKS	TBLS	2 189,00
	14	SKS	TBLS	2 258,00
	16	SKS	TBLS	2 487,00
385/65 - 22.5 (15 x 22.5)	12	SKS	TBLS	2 535,00
	16	SKS	TBLS	2 688,00
	20	SKS	TBLS	3 471,00

Wersje / mieszanki za dopłatą:

ECR+ +10%

ELCON +10%

NON-MARKING (GREY) +50%



Solideal Crane WL



Crane WL

Rozmiar opony	Liczba PR	Bieżnik	Dętka	Cena detaliczna zł netto/szt
8.25 - 20	12	Widelug	TT	988,00
8.25 - 20	14	Widelug	TT	1 040,00
9.00 - 20	14	Widelug	TT	1 109,00
10.00 - 20	14	Widelug	TT	1 199,00
10.00 - 20	16	Widelug	TT	1 236,00
11.00 - 20	16	Widelug	TT	1 578,00

Wersje / mieszanki za dopłatą:

ECR+ +10%

NON-MARKING (GREY) +50%

ELCON +10%



Solideal pierścień dystansowy



Pierścień dystansowy

Rozmiar pierścienia				Cena detaliczna zł netto/szt
860 x 450 x 30				w przygotowaniu
860 x 450 x 40				w przygotowaniu
860 x 450 x 50				372,00
860 x 450 x 60				489,00
860 x 450 x 70				591,00
860 x 450 x 80				655,00
860 x 450 x 90				w przygotowaniu
860 x 450 x 100				814,00



SL G2/L2

SL G3/L3

Solideal Grader SL G2/L2 SL G3/L3

Rozmiar opony	Liczba PR	Bieżnik	Dętka	Cena detaliczna zł netto/szt
13.00 - 24 TG	10	Superlug G2/L2	TBLS	1 952,00
	12	Superlug G2/L2	TBLS	2 054,00
	12	Superlug G3/L3	TBLS	2 480,00
	14	Superlug G2/L2	TBLS	2 196,00
	16	Superlug G2/L2	TBLS	2 280,00
	16	Superlug G3/L3	TBLS	2 791,00
14.00 - 24 TG	10	Superlug G2/L2	TBLS	2 251,00
	12	Superlug G2/L2	TBLS	2 259,00
	12	Superlug G3/L3	TBLS	2 728,00
	14	Superlug G2/L2	TBLS	2 382,00
	16	Superlug G2/L2	TBLS	2 589,00
	16	Superlug G3/L3	TBLS	3 192,00



SM C1

Solideal Compactor SM C1

Rozmiar opony	Liczba PR	Bieżnik	Dętka	Cena detaliczna zł netto/szt
7.50 - 15 NHS	6	Smooth C1	TT	564,00
	10	Smooth C1	TT	584,00
	12	Smooth C1	TT	609,00
	14	Smooth C1	TT	628,00
8.50/90 - 15 K	6	Smooth C1	TBLS	579,00
11.00 - 20 NHS	12	Smooth C1	TT	2 084,00
	16	Smooth C1	TT	2 193,00
	18	Smooth C1	TT	2 308,00
	20	Smooth C1	TT	2 429,00



4L I3

4L R1

SL R4

TM R4

Tractionmaster

Tractionmaster

Solideal MPT 4L I3 SL R4 / TM R4 / 4L R1

Rozmiar opony	Liczba PR	Bieżnik	Dętka	Cena detaliczna zł netto/szt
10.5 - 18	8	MPT LUG 4L I3	TBLS	1 007,00
	10	MPT LUG 4L I3	TBLS	1 071,00
12.5 - 18 (340/80 - 18)	10	MPT LUG 4L I3	TBLS	1 212,00
	10	MPT Super Lug R4	TBLS	1 289,00
	12	MPT LUG 4L I3	TBLS	1 222,00
	12	MPT 4L R1 Tractionmaster	TBLS	1 281,00
	12	MPT Super Lug R4	TBLS	1 284,00
18 - 19,5 (445/65 - 19,5)	16	MPT 4L R1 Tractionmaster	TBLS	2 072,00
	16	MPT TM R4 Tractionmaster	TBLS	2 136,00
	20	MPT 4L R1 Tractionmaster	TBLS	na zamówienie
10.5 - 20	10	MPT LUG 4L I3	TBLS	1 199,00
12.5 - 20 (340/80 - 20)	10	MPT LUG 4L I3	TBLS	1 524,00
	12	MPT LUG 4L I3	TBLS	1 571,00
14.5 - 20 (420/75 - 20)	10	MPT LUG 4L I3	TBLS	1 560,00
	12	MPT LUG 4L I3	TBLS	1 642,00
	14	MPT LUG 4L I3	TBLS	1 729,00
405/70 - 20 (16/70-20)	10	MPT 4L R1 Tractionmaster	TBLS	1 689,00
	12	MPT LUG 4L I3	TBLS	1 692,00
	12	MPT 4L R1 Tractionmaster	TBLS	2 084,00
	14	MPT LUG 4L I3	TBLS	1 767,00
	14	MPT TM R4 Tractionmaster	TBLS	2 421,00
	14	MPT 4L R1 Tractionmaster	TBLS	2 171,00
18 - 22,5 (445/65 - 22,5)	16	MPT 4L R1 Tractionmaster	TBLS	2 994,00
	16	MPT TM R4 Tractionmaster	TBLS	3 086,00
15,5/80 - 24 (400/80 - 24)	12	MPT 4L R1 Tractionmaster	TBLS	1 949,00
	14	MPT 4L R1 Tractionmaster	TBLS	2 046,00
	16	MPT 4L R1 Tractionmaster	TBLS	2 148,00
16,5/85 - 24	8	MPT 4L R1 Tractionmaster	TBLS	2 102,00
	12	MPT 4L R1 Tractionmaster	TBLS	2 306,00
	14	MPT 4L R1 Tractionmaster	TBLS	2 440,00
	16	MPT 4L R1 Tractionmaster	TBLS	2 577,00
405/70 - 24 (16/70-24)	14	MPT LUG 4L I3	TBLS	2 245,00
	14	MPT 4L R1 Tractionmaster	TBLS	2 357,00



Solideal Backhoe SL R4 / MR F3 R1 Tractionmaster 4L R1 Tractionmaster



SL R4 MR F3 4L R1 R1
Tractionmaster Tractionmaster

Rozmiar opony	Liczba PR	Bieżnik	Dętka	Cena detaliczna zł netto/szt
11L - 15SL IMP	8	Multi Rib F3	TBLS	619,00
	10	Multi Rib F3	TBLS	652,00
11L - 16SL IMP	10	Multi Rib F3	TBLS	635,00
	12	Multi Rib F3	TBLS	667,00
14.5/75 - 16.1 SL	10	Multi Rib F3	TBLS	1 338,00
10.5/80 - 18 IMP	10	Super Lug R4	TBLS	941,00
	12	Super Lug R4	TBLS	988,00
12.5/80 - 18 IMP (320/80 - 18)	10	Super Lug R4	TBLS	1 188,00
	12	Traction Master R1	TBLS	1 272,00
	12	Super Lug R4	TBLS	1 217,00
	14	Super Lug R4	TBLS	1 280,00
14.9 - 24 IND	6	Super Lug R4	TBLS	2 127,00
	8	Super Lug R4	TBLS	2 262,00
	12	Super Lug R4	TBLS	2 458,00
16.9 - 24 IND (440/80 - 24)	8	Super Lug R4	TBLS	2 207,00
	10	Super Lug R4	TBLS	2 293,00
	12	Super Lug R4	TBLS	2 415,00
17.5L-24 IND (460/70 - 24)	6	Super Lug R4	TBLS	2 579,00
	8	Super Lug R4	TBLS	2 706,00
	10	Traction Master 4L R1	TBLS	2 796,00
	10	Super Lug R4	TBLS	2 861,00
	12	Super Lug R4	TBLS	2 942,00
19.5L - 24 IND (500/70 - 24)	8	Super Lug R4	TBLS	2 942,00
	10	Super Lug R4	TBLS	2 973,00
	12	Super Lug R4	TBLS	3 130,00
	14	Super Lug R4	TBLS	3 301,00
21L - 24 IND	10	Super Lug R4	TBLS	2 898,00
	12	Super Lug R4	TBLS	3 001,00
	16	Super Lug R4	TBLS	3 648,00
18.4 - 26 IND (480/80 - 26)	12	Super Lug R4	TT/TBLS	2 742,00
	12	Traction Master 4L R1	TT/TBLS	2 879,00
16.9 - 28 IND (440/80 - 28)	8	Super Lug R4	TT/TBLS	2 270,00
	10	Super Lug R4	TT/TBLS	2 357,00
	12	Super Lug R4	TT/TBLS	2 473,00
	12	Traction Master 4L R1	TT/TBLS	2 283,00
18.4 - 28 IND	10	Super Lug R4	TT/TBLS	2 589,00
	12	Traction Master 4L R1	TT/TBLS	2 671,00
	12	Super Lug R4	TT/TBLS	2 754,00
16.9 - 30 IND	10	Super Lug R4	TT/TBLS	2 691,00
	12	Super Lug R4	TT/TBLS	2 824,00
	14	Super Lug R4	TT/TBLS	2 966,00

Wersje / mieszanki za dopłatą:

ECR+ +10%

ELCON +10%

NON-MARKING (GREY) +50%



Solideal Backhoe SLA R4



SLA R4

Rozmiar opony	Liczba PR	Bieżnik	Dętka	Cena detaliczna zł netto/szt
14.9 - 24 IND	12	SLA R4	TBLS/TT	2 531,00
16.9 - 24 IND (440/80 - 24)	12	SLA R4	TBLS/TT	2 487,00
17.5L - 24 IND (460/70 - 24)	10	SLA R4	TBLS/TT	2 946,00
19.5L - 24 IND (500/70 - 24)	10	SLA R4	TBLS/TT	3 062,00
21L - 24 IND	12	SLA R4	TBLS/TT	3 091,00
18.4 - 26 (480/80 - 26)	12	SLA R4	TBLS/TT	2 824,00
16.9 - 28 (440/80 - 28)	12	SLA R4	TBLS/TT	2 547,00



4L R4

4L R1
Tractionmaster

Solideal Dumper 4L R4 / 4L R1

Rozmiar opony	Liczba PR	Bieżnik	Dętka	Cena detaliczna zł netto/szt
10.0/75 - 15.3	8	MPT LUG 4L R4	TBLS	737,00
	8	MPT Tractionmaster 4L R1	TBLS	753,00
	10	MPT LUG 4L R4	TBLS	788,00
11.5/80 - 15.3	8	MPT LUG 4L R4	TBLS	792,00
	8	MPT Tractionmaster 4L R1	TBLS	927,00
	10	MPT LUG 4L R4	TBLS	800,00
	14	MPT LUG 4L R4	TBLS	1 020,00

Wersje / mieszanki za dopłatą:

ECR+ +10%

NON-MARKING (GREY) +50%

ELCON +10%



LM L2/G2/E2 LM L3/G3/E3 RM L3/G3/E3
L4/G4/E4 SKZ
Lifemaster

Solideal **LM L2/G2/E2** **L3/G3/E3** **RM L3/G3/E3** **L4/G4/E4**

Rozmiar opony	Liczba PR	Bieżnik	Dętka	Cena detaliczna zł netto/szt
15.5-25	12	Loadmaster SL L2/E2/G2	TBLS	2 574,00
	12	Loadmaster L3/G3/E3	TBLS	3 015,00
	16	Loadmaster SL L2/E2/G2	TBLS	3 090,00
	16	Loadmaster L3/G3/E3	TBLS	3 325,00
17.5-25	12	Loadmaster SL L2/E2/G2	TBLS	3 156,00
	12	Loadmaster L3/G3/E3	TBLS	4 132,00
	16	Loadmaster SL L2/E2/G2	TBLS	3 435,00
	16	Loadmaster L3/G3/E3	TBLS	4 547,00
	16	RM L3/G3/E3	TBLS	4 774,00
	20	Loadmaster L3/G3/E3	TBLS	5 001,00
20.5-25	12	Loadmaster SL L2/E2/G2	TBLS	4 041,00
	16	Loadmaster SL L2/E2/G2	TBLS	4 754,00
	16	Loadmaster L3/G3/E3	TBLS	5 191,00
	16	SKZ	TBLS	6 488,00
	20	Loadmaster SL L2/E2/G2	TBLS	5 347,00
	20	Loadmaster L3/G3/E3	TBLS	5 673,00
	20	RM L3/G3/E3	TBLS	5 956,00
23.5 - 25	16	Loadmaster L3/G3/E3	TBLS	6 803,00
	20	Loadmaster L3/G3/E3	TBLS	7 154,00
	20	RM L3/G3/E3	TBLS	7 512,00
	24	Loadmaster L3/G3/E3	TBLS	7 571,00
	24	RM L3/G3/E3	TBLS	7 950,00
	20	Loadmaster L3/G3/E3	TBLS	11 558,00
26.5 - 25	20	RM L3/G3/E3	TBLS	12 136,00
	24	Loadmaster L3/G3/E3	TBLS	na zamówienie
	24	RM L3/G3/E3	TBLS	na zamówienie
	28	Loadmaster L3/G3/E3	TBLS	12 105,00
	28	RM L3/G3/E3	TBLS	na zamówienie
	28	Loadmaster L3/G3/E3	TBLS	15 738,00
29.5 - 25	28	RM L3/G3/E3	TBLS	16 525,00
	40	RM L4/G4/E4	TBLS	25 126,00

Wersje / mieszanki za dopłatą:

ECR+ +10%

ELCON +10%

NON-MARKING (GREY) +50%



SRGP

SRAT

SRLD

SRLS

SRLT

Solideal SRGP, SRAT SRLD, SRLS, SRLT Ind

Rozmiar opony	Liczba PR	Bieżnik	Dętka	Cena detaliczna zł netto/szt
17.5R25 **/**		SRGP L3/E3	TBLS	5 836,00
20.5R25 **/**		SRGP L3/E3	TBLS	8 500,00
23.5R25 **/**		SRGP L3/E3	TBLS	11 360,00
26.5R25 **/**		SRGP L3/E3	TBLS	19 084,00
29.5R25 **/**		SRGP L3/E3	TBLS	26 731,00
23.5R25 **/**		SRAT E3/L3	TBLS	11 360,00
26.5R25 **/**		SRAT E3/L3	TBLS	19 084,00
29.5R25 **/**		SRAT E3/L3	TBLS	26 731,00
29.5R29 **/**		SRAT E4/L4	TBLS	29 440,00
23.5R25 **		SRLD L5	TBLS	w przygotowaniu
26.5R25 **		SRLD L5	TBLS	w przygotowaniu
29.5R25 **		SRLD L5	TBLS	w przygotowaniu
26.5R25 **		SRLS L5S	TBLS	w przygotowaniu
29.5R25 **		SRLS L5S	TBLS	w przygotowaniu
29.5R29 **		SRLS L5S	TBLS	w przygotowaniu
14.00R24		SRLT Ind	TBLS	w przygotowaniu
16.00R25		SRLT Ind	TBLS	w przygotowaniu
18.00R25		SRLT Ind	TBLS	w przygotowaniu

Wersje / mieszanki za dopłatą:

ECR+ +10%

NON-MARKING (GREY) +50%

ELCON +10%



Solideal — konwencjonalne gąsienice gumowe



Typ A

Typ S

Typ X

Rozmiar gąsienicy		Kraj pochodzenia		Cena detaliczna zł netto/szt
130X29X72 AAR (Brokk)		Sri Lanka		767,00
150X28X72 AAR		Sri Lanka		880,00
150X33X72 AAR		Sri Lanka		1 036,00
150X34X72 AAR		Sri Lanka		1 068,00
180X28X60 SAF		Sri Lanka		670,00
180X30X60 SAF		Sri Lanka		718,00
180X31X60 SAF		Sri Lanka		743,00
180X32X60 SAF		Sri Lanka		766,00
180X33X60 SAF		Sri Lanka		791,00
180X34X60 SAF		Sri Lanka		814,00
180X35X60 SAF		Sri Lanka		838,00
180X36X60 SAF		Sri Lanka		861,00
180X37X60 SAF		Sri Lanka		886,00
180X38X60 SAF		Sri Lanka		909,00
180X40X60 SAF		Sri Lanka		957,00
180X30X72 XAR		Sri Lanka		954,00
180X31X72 XAR		Sri Lanka		986,00
180X32X72 XAR		Sri Lanka		1 018,00
180X33X72 XAR		Sri Lanka		1 049,00
180X34X72 XAR		Sri Lanka		1 079,00
180X35X72 XAR		Sri Lanka		1 114,00
180X36X72 XAR		Sri Lanka		1 147,00
180X37X72 XAR		Sri Lanka		1 176,00
180X38X72 XAR		Sri Lanka		1 208,00
180X39X72 XAR		Sri Lanka		1 233,00
180X40X72 XAR		Sri Lanka		1 262,00
180X41X72 XAR		Sri Lanka		1 304,00
180X42X72 XAR		Sri Lanka		1 335,00
180X47X72 XAR		Sri Lanka		1 494,00
180X58X72 XAR		Sri Lanka		1 844,00
200X42X72 AAR		Sri Lanka		1 165,00
200X49X72 AAR		Sri Lanka		1 358,00
200X56X72 AAR		Sri Lanka		1 553,00

Wersje / mieszanki za dopłatą:

NON-MARKING (GREY) +50%



Solideal — konwencjonalne gąsienice gumowe



Typ A

Typ X

Typ Z

Rozmiar gąsienicy		Kraj pochodzenia		Cena detaliczna zł netto/szt
200X34X72 AAP		Sri Lanka		1 137,00
200X37X72 AAP		Sri Lanka		1 204,00
200X38X72 AAP		Sri Lanka		1 237,00
200X39X72 AAP		Sri Lanka		1 271,00
200X40X72 AAP		Sri Lanka		1 304,00
200X41X72 AAP		Sri Lanka		1 337,00
200X42X72 AAP		Sri Lanka		1 372,00
200X43X72 AAP		Sri Lanka		1 404,00
200X44X72 AAP		Sri Lanka		1 438,00
200X46X72 AAP		Sri Lanka		1 538,00
200X47X72 AAP		Sri Lanka		1 570,00
200X48X72 AAP		Sri Lanka		1 605,00
200X50X72 AAP		Sri Lanka		1 672,00
200X52X72 AAP		Sri Lanka		1 739,00
200X54X72 AAP		Sri Lanka		1 805,00
200X56X72 AAP		Sri Lanka		1 872,00
230X38X72 AAP		Sri Lanka		1 238,00
230X39X72 AAP		Sri Lanka		1 271,00
230X41X72 AAP		Sri Lanka		1 335,00
230X42X72 AAP		Sri Lanka		1 138,00
230X43X72 AAP		Sri Lanka		1 167,00
230X44X72 AAP		Sri Lanka		1 433,00
230X45X72 AAP		Sri Lanka		1 466,00
230X46X72 AAP		Sri Lanka		1 498,00
230X47X72 AAP		Sri Lanka		1 532,00
230X48X72 AAP		Sri Lanka		1 564,00
230X50X72 AAP		Sri Lanka		1 629,00
230X52X72 AAP		Sri Lanka		1 695,00
230X54X72 AAP		Sri Lanka		1 758,00
230X56X72 AAP		Sri Lanka		1 824,00
230X59X72 AAP		Sri Lanka		1 922,00

Wersje / mieszanki za dopłatą:
NON-MARKING (GREY) +50%



Solideal — konwencjonalne gąsienice gumowe



Typ D

Typ Q

Typ J

Typ B

Rozmiar gąsienicy		Kraj pochodzenia		Cena detaliczna zł netto/szt
250X45X72 DAP		Sri Lanka		2 077,00
250X46X72 DAP		Sri Lanka		2 124,00
250X47X72 DAP		Sri Lanka		2 169,00
250X48X72 DAP		Sri Lanka		2 216,00
250X49X72 DAP		Sri Lanka		2 262,00
250X50X72 DAP		Sri Lanka		2 308,00
250X52X72 DAP		Sri Lanka		2 400,00
250X54X72 DAP		Sri Lanka		2 493,00
250X55X72 DAP		Sri Lanka		2 539,00
250X56X72 DAP		Sri Lanka		2 585,00
250X57X72 DAP		Sri Lanka		2 632,00
250X60X72 DAP		Sri Lanka		2 770,00
320X37X100 QAW		Sri Lanka		3 343,00
320X38X100 QAW		Sri Lanka		3 434,00
320X40X100 QAW		Sri Lanka		3 615,00
320X41X100 QAW		Sri Lanka		3 705,00
320X42X100 QAW		Sri Lanka		3 795,00
320X43X100 QAW		Sri Lanka		3 886,00
320X44X100 QAW		Sri Lanka		3 975,00
320X45X100 QAW		Sri Lanka		4 066,00
320X46X100 QAW		Sri Lanka		4 156,00
320X49X100 QAW		Sri Lanka		4 428,00
320X50X100 QAW		Sri Lanka		4 518,00
320X52X100 QAW		Sri Lanka		4 698,00
320X47X87 JJW		Sri Lanka		6 800,00
320X51X87 JJW		Sri Lanka		7 379,00
320X47X87 BJW		Sri Lanka		6 800,00
320X51X87 BJW		Sri Lanka		7 379,00
320X48X84 BBE		Sri Lanka		6 230,00
320X49X84 BBE		Sri Lanka		6 361,00
320X50X84 BBE		Sri Lanka		6 489,00
320X53X84 BBE		Sri Lanka		6 879,00
320X46X86 BBE		Sri Lanka		6 097,00
320X47X86 BBE		Sri Lanka		6 230,00
320X49X86 BBE		Sri Lanka		6 495,00
320X50X86 BBE		Sri Lanka		6 628,00
320X52X86 BBE		Sri Lanka		6 893,00

Wersje / mieszanki za dopłatą:

NON-MARKING (GREY) +50%



Solideal — konwencjonalne gąsienice gumowe



Typ C

Typ B

Typ L

Typ E

Typ G

Rozmiar gąsienicy		Kraj pochodzenia		Cena detaliczna zł netto/szt
320X38X100 CAP		Japan		5 388,00
320X40X100 CAP		Japan		5 673,00
320X56X90 EBW		Japan		6 606,00
420X52X100 LAE		Sri Lanka		7 984,00
420X54X100 LAE		Sri Lanka		8 290,00
420X58X100 LAE		Sri Lanka		8 906,00
450X53X84 BBE		Sri Lanka		7 910,00
450X56X84 BBE		Sri Lanka		8 358,00
450X60X84 BBE		Sri Lanka		8 956,00
450X52X86 BBE		Sri Lanka		7 910,00
450X55X86 BBE		Sri Lanka		8 368,00
450X48X100 BJE		Japan		12 828,00
450X50X100 BJE		Japan		13 363,00
450X60X90 EBW		Sri Lanka		8 414,00
500X78X90 CBW		Japan		19 673,00
500X82X90 GBE		Japan		20 786,00
600X80X100 CBG		Japan		32 088,00
600X82X100 CBG		Japan		32 891,00
650X88X110 CBG		Japan		51 600,00
700X80X100 CBJ		Japan		48 829,00
700X98X100 CBJ		Japan		59 814,00
750X66X150 CBL		Japan		64 872,00
800X80X125 CBH		Japan		69 477,00
800X67X150 GBM		Japan		77 808,00
800X68X150 GBB		Sri Lanka		54 367,00

Wersje / mieszanki za dopłatą:
NON-MARKING (GREY) +50%



Solideal — wymienne gąsienice gumowe



Typ S

Typ V1

Typ V

Typ Y2

Typ Y3

Rozmiar gąsienicy		Kraj pochodzenia		Cena detaliczna zł netto/szt
230X60X48 SIK-F/KIK		Sri Lanka		1 862,00
230X62X48 SIK-F/KIK		Sri Lanka		1 923,00
230X64X48 SIK-F/KIK		Sri Lanka		1 985,00
230X66X48 SIK-F/KIK		Sri Lanka		2 048,00
230X68X48 SIK-F/KIK		Sri Lanka		2 109,00
230X70X48 SIK-F/KIK		Sri Lanka		2 171,00
230X72X48 SIK-F/KIK		Sri Lanka		2 234,00
230X74X48 SIK-F/KIK		Sri Lanka		2 295,00
230X80X48 SIK-F/KIK		Sri Lanka		2 481,00
250X62X48 V1IK		Sri Lanka		2 362,00
250X66X48 V1IK		Sri Lanka		2 515,00
250X72X48 V1IK		Sri Lanka		2 744,00
250X74X48 V1IK		Sri Lanka		2 820,00
250X76X48 V1IK		Sri Lanka		2 895,00
250X78X48 V1IK		Sri Lanka		2 972,00
250X80X48 V1IK		Sri Lanka		3 048,00
250X82X48 V1IK		Sri Lanka		3 124,00
250x76x52.5 V3IS		Sri Lanka		2 690,00
260X78X49.2 Y3LK		Sri Lanka		4 522,00
260X82X49.2 Y3LK		Sri Lanka		4 754,00
300X78X52.5 VIW-FCR		Sri Lanka		5 030,00
300X84X52.5 VIW-FCR		Sri Lanka		5 217,00
300X84X52.5 VIW-F		Sri Lanka		5 217,00
300X80X53 V1JSA		Sri Lanka		5 316,00
300X84X53 V1JSA		Sri Lanka		5 581,00
300X70X55 V1ISA		Sri Lanka		4 347,00
300X71X55 V1ISA		Sri Lanka		4 409,00
300X75X55 V1ISA		Sri Lanka		4 658,00
300X77X55 V1ISA		Sri Lanka		4 783,00
300X75X55 V1ISA		Sri Lanka		4 845,00
300X81X55 V1ISA		Sri Lanka		5 030,00
300X83X55 V1ISA		Sri Lanka		5 155,00
300X72X55 Y2IS-F		Sri Lanka		4 472,00
300X68X55 Y2JS-F		Sri Lanka		4 975,00
300X73X55 Y2JS-F		Sri Lanka		5 342,00
300X75X55 Y2JS-F		Sri Lanka		5 487,00
300X76X55 Y2JS-F		Sri Lanka		5 560,00
300X77X55 Y2JS-F		Sri Lanka		5 487,00
300X81X55 Y2JS-F		Sri Lanka		5 926,00
300X82X55 Y2JS-F		Sri Lanka		5 999,00

Wersje / mieszanki za dopłatą:

NON-MARKING (GREY) +50%



Solideal — wymienne gąsienice gumowe



Typ V1

Typ V

Typ Y2

Rozmiar gąsienicy		Kraj pochodzenia		Cena detaliczna zł netto/szt
300X75X55 V1IWA		Sri Lanka		4 658,00
300X77X55 V1IWA		Sri Lanka		4 783,00
300X79X55 V1IWA		Sri Lanka		4 906,00
300X81X55 V1IWA		Sri Lanka		5 030,00
300X85X55 V1IWA		Sri Lanka		5 278,00
300X68X55 V1IWF/Y2IWF-F		Sri Lanka		4 223,00
300X69X55 V1IWF/Y2IWF-F		Sri Lanka		4 286,00
300X70X55 V1IWF/Y2IWF-F		Sri Lanka		4 347,00
300X71X55 V1IWF/Y2IWF-F		Sri Lanka		4 409,00
300X73X55 V1IWF/Y2IWF-F		Sri Lanka		4 534,00
300X74X55 V1IWF/Y2IWF-F		Sri Lanka		4 596,00
300X75X55 V1IWF/Y2IWF-F		Sri Lanka		4 658,00
300X76X55 V1IWF/Y2IWF-F		Sri Lanka		4 719,00
300X77X55 V1IWF/Y2IWF-F		Sri Lanka		4 783,00
300X78X55 V1IWF/Y2IWF-F		Sri Lanka		4 845,00
300X79X55 V1IWF/Y2IWF-F		Sri Lanka		4 906,00
300X81X55 V1IWF/Y2IWF-F		Sri Lanka		5 030,00
300X82X55 V1IWF/Y2IWF-F		Sri Lanka		5 093,00
300X83X55 V1IWF/Y2IWF-F		Sri Lanka		5 155,00
300X84X55 V1IWF/Y2IWF-F		Sri Lanka		5 217,00
300X87X55 V1IWF/Y2IWF-F		Sri Lanka		5 404,00
300X70X55 V1IS-F		Sri Lanka		4 347,00
300X71X55 V1IS-F		Sri Lanka		4 409,00
300X72X55 V1IS-F		Sri Lanka		4 472,00
300X73X55 V1IS-F		Sri Lanka		4 534,00
300X74X55 V1IS-F		Sri Lanka		4 596,00
300X75X55 V1IS-F		Sri Lanka		4 658,00
300X76X55 V1IS-F		Sri Lanka		4 719,00
300X77X55 V1IS-F		Sri Lanka		4 783,00
300X78X55 V1IS-F		Sri Lanka		4 845,00
300X79X55 V1IS-F		Sri Lanka		4 906,00
300X80X55 V1IS-F		Sri Lanka		4 968,00
300X81X55 V1IS-F		Sri Lanka		5 030,00
300X82X55 V1IS-F		Sri Lanka		5 093,00
300X83X55 V1IS-F		Sri Lanka		5 155,00
300X88X55 V1IS-F		Sri Lanka		5 465,00
300X90X55 V1IS-F		Sri Lanka		5 591,00
300X76X55.5 Y2JS-F		Sri Lanka		5 400,00
300X82X55.5 Y2JS-F		Sri Lanka		5 828,00

Wersje / mieszanki za dopłatą:
NON-MARKING (GREY) +50%



Solideal — wymienne gąsienice gumowe



Typ Y3

Typ V

Typ V1

Rozmiar gąsienicy		Kraj pochodzenia		Cena detaliczna zł netto/szt
320X71X55 VIS-F		Sri Lanka		5 203,00
320X77X55 VIS-F		Sri Lanka		5 643,00
320X88X55 VIS-F		Sri Lanka		6 448,00
320X94X55 VIS-F		Sri Lanka		6 888,00
350X86X54.5 V1JWA		Sri Lanka		7 444,00
350X80X56 V1IW-F		Sri Lanka		6 688,00
350X82X56 V1IW-F		Sri Lanka		6 856,00
350X84X56 V1IW-F		Sri Lanka		7 023,00
350X86X56 V1IW-F		Sri Lanka		7 189,00
400X72X72.5 Y3LJ		Japan		12 717,00
400X92X53.5 Y3LW		Japan		13 198,00
400X68X72.5 V1IEA		Sri Lanka		6 703,00
400X70X72.5 V1IEA		Sri Lanka		6 849,00
400X72X72.5 V1IEA		Sri Lanka		7 097,00
400X74X72.5 V1IEA		Sri Lanka		7 295,00
400X76X72.5 V1IEA		Sri Lanka		7 934,00
400X82X72.5 V1IEA		Sri Lanka		8 487,00
400X88X72.5 V1IEA		Sri Lanka		8 960,00
400X88X72.5 VIEF-R		Sri Lanka		8 848,00
400X72X72.5 V1IWA		Sri Lanka		7 097,00
400X74X72.5 V1IWA		Sri Lanka		7 295,00
400X68X72.5 VIE-F		Sri Lanka		6 703,00
400X70X72.5 VIE-F		Sri Lanka		6 901,00
400X72X72.5 VIE-F		Sri Lanka		7 097,00
400X74X72.5 VIE-F		Sri Lanka		7 295,00
400X76X72.5 VIE-F		Sri Lanka		7 492,00
400X78X72.5 VIE-F		Sri Lanka		7 689,00
400X80X72.5 VIE-F		Sri Lanka		7 886,00
400X82X72.5 VIE-F		Sri Lanka		8 083,00
400X86X72.5 VIE-F		Sri Lanka		8 477,00
400X88X72.5 VIE-F		Sri Lanka		8 848,00
400X70X72.5 VIW-F		Sri Lanka		6 901,00
400X72X72.5 VIW-F		Sri Lanka		7 097,00
400X73X72.5 VIW-F		Sri Lanka		7 195,00
400X74X72.5 VIW-F		Sri Lanka		7 295,00
400X82X72.5 VIW-F		Sri Lanka		8 083,00

Wersje / mieszanki za dopłatą:

NON-MARKING (GREY) +50%



Solideal — wymienne gąsienice gumowe



Typ Y3

Typ V

Typ V1

Typ S2

Rozmiar gąsienicy		Kraj pochodzenia		Cena detaliczna zł netto/szt
400X70X72.5 V1JS-F		Sri Lanka		10 687,00
400X72X72.5 V1JS-F		Sri Lanka		10 993,00
400X70X72.5 Y3KC		Japan		14 744,00
400X72X72.5 Y3KC		Japan		15 165,00
400X74X72.5 Y3KC		Japan		15 586,00
400X78X72.5 Y3KC		Japan		16 428,00
400X82X72.5 Y3KC		Japan		17 270,00
400X80X72.5 Y3KJ		Sri Lanka		16 382,00
450X76X81 V1IAA		Sri Lanka		13 377,00
450X80X71 V1IJA		Sri Lanka		13 206,00
450X82X71 V1IJA		Sri Lanka		13 902,00
450X84X71 V1IJA		Sri Lanka		14 249,00
450X86X71 V1IJA		Sri Lanka		14 944,00
450X88X71 V1IJA		Sri Lanka		15 291,00
450X76X81 V1IOA		Sri Lanka		12 673,00
450X80X71 S2IJ-F		Sri Lanka		14 170,00
450X82X71 S2IJ-F		Sri Lanka		14 526,00
450X84X71 S2IJ-F		Sri Lanka		14 881,00
450X86X71 S2IJ-F		Sri Lanka		15 234,00
450X88X71 S2IJ-F		Sri Lanka		15 588,00
450X80X75.5 V3IJA		Sri Lanka		14211,00
450X72X81 VIA-F		Sri Lanka		12 673,00
450X76X81 VIA-F		Sri Lanka		13 377,00
450X78X81 VIA-F		Sri Lanka		13 728,00
450X80X81 VIA-F		Sri Lanka		14 081,00
450X72X83 Y3KJ		Japan		20 908,00
450X74X83 Y3KJ		Japan		21 713,00
450X80X73.5 Y3IO		Japan		17 263,00
450X86X73.5 Y3IO		Japan		18 557,00
500X78X92 V1IDA		Sri Lanka		21 632,00
500X80X92 V1IDA		Sri Lanka		22 187,00
500X82X92 V1IDA		Sri Lanka		22 742,00
500X84X92 V1IDA		Sri Lanka		23 296,00

Wersje / mieszanki za dopłatą:
NON-MARKING (GREY) +50%



Gąsienice Solideal OTT



6H - 2"



6H - 3,5"



8H - 2"



8H - 3,5"

Rozmiar gąsienicy		Kraj pochodzenia		Cena detaliczna zł netto/szt
Stosowane na opony 10 x 16.5				
10 X 26 X 16.5		Sri Lanka		6 345,00
10 X 28 X 16.5		Sri Lanka		6 772,00
10 X 29X 16.5		Sri Lanka		6 994,00
10 X 30X 16.5		Sri Lanka		7 215,00
10 X 31X 16.5		Sri Lanka		7 550,00
Stosowane na opony 12 x 16.5				
12 X 30X 16.5		Sri Lanka		8 326,00
12 X 31X 16.5		Sri Lanka		8 547,00
12 X 32X 16.5		Sri Lanka		8 769,00
12 X 33X 16.5		Sri Lanka		8 991,00
12 X 34X 16.5		Sri Lanka		9 214,00
Dystanse (komplet 4 szt.)				
2" 6 - otworowa		Sri Lanka		250,00
2" 8 - otworowa		Sri Lanka		250,00
3,5" 6 - otworowa		Sri Lanka		250,00
3,5" 8 - otworowa		Sri Lanka		250,00

Uwaga:

Każda gąsienica OTT dostarczana jest razem z pełnym ogniwnem + 1/2 ogniwa + 3/4 ogniwa oraz dodatkowym łącznikiem i szpilkami.



Gąsienice Solideal OTT



Rozmiar gąsienicy		Kraj pochodzenia		Cena detaliczna zł netto/szt
10 x 16.5 OTT				
T211733 ½ ogniwa		Sri Lanka		214,00
T211734 ¾ ogniwa		Sri Lanka		319,00
T211735 pełne ogniwo		Sri Lanka		426,00
T211740 szpilka do motażu ogniw (5 wymagane)		Sri Lanka		48,00
T211757 szpilka prowadząca (2 wymagane)		Sri Lanka		33,00
T211779 pas z napinaczem zapdkowym		Sri Lanka		245,00
14M7455 nakrętka (7 wymagane)		Sri Lanka		7,00
24M7427 podkładka (12 wymagane)		Sri Lanka		3,00
12 x 16.5 OTT				
T211736 ½ ogniwa		Sri Lanka		266,00
T211737 ¾ ogniwa		Sri Lanka		399,00
T211738 pełne ogniwo		Sri Lanka		532,00
T211741 szpilka do motażu ogniw (5 wymagane)		Sri Lanka		75,00
T211757 szpilka prowadząca (2 wymagane)		Sri Lanka		33,00
T211779 pas z napinaczem zapdkowym		Sri Lanka		245,00
14M7455 nakrętka (7 wymagane)		Sri Lanka		7,00
24M7427 podkładka (12 wymagane)		Sri Lanka		3,00

Uwaga:

Pełny zestaw łączący gąsienice zawiera: 5 szpilek + 7 nakrętek + 12 podkładek + 2 szpilki prowadzące.



Gąsienice Solideal serii Leopard



Rozmiar gąsienicy	Profil				Statyczny nacisk powierzchniowy	Prowadzenie		Karkas		Warstwy	Cena
	Szerokość	Element	Głębokość	Powierzchnia styku z podłożem		Typ	Element	Środek	Bok		
John Deere seria T8000 Prowadzenie GE 6" - Długość gąsienicy 324"											
16"x54x6" Leopard (GE 6")	16"	6"	2,25 -> 2,5"	948 cal ²	11,1 psi	GE	6"	1,25"	1"	4	20 364,00
18"x54x6" Leopard (GE 6")	18"	6"	2,25 -> 2,5"	1 067 cal ²	9,8 psi	GE	6"	1,25"	1"	4	23 421,00
24"x54x6" Leopard (GE 6")	24"	6"	2,25 -> 2,5"	1 423 cal ²	7,4 psi	GE	6"	1,25"	1"	4	27 528,00
30"x54x6" Leopard (GE 6")	30"	6"	2,25 -> 2,5"	1 778 cal ²	5,9 psi	GE	6"	1,25"	1"	4	36 609,00

John Deere seria T9000 Prowadzenie GQ 6" - Długość gąsienicy 378"											
30"x63x6" Leopard (GQ 6")	30"	6"	2,25 -> 2,5"	2 218 cal ²	7,5 psi	GQ	6"	1,25"	1"	4	44 753,00
36"x63x6" Leopard (GQ 6")	36"	6"	2,25 -> 2,5"	2 661 cal ²	6,3 psi	GQ	6"	1,25"	1"	4	50 219,00

CAT/Claas 35/45/55 Prowadzenie GF 6" - Długość gąsienicy 318"											
16"x53x6" Leopard (GF 6")	16"	6"	2,25 -> 2,5"	916 cal ²	9,6 psi	GF	6"	1,25"	1"	4	19 985,00
18"x53x6" Leopard (GF 6")	18"	6"	2,25 -> 2,5"	1 022 cal ²	8,6 psi	GF	6"	1,25"	1"	4	22 987,00
24"x53x6" Leopard (GF 6")	24"	6"	2,25 -> 2,5"	1 375 cal ²	6,4 psi	GF	6"	1,25"	1"	4	27 023,00
30"x53x6" Leopard (GF 6")	30"	6"	2,25 -> 2,5"	1 703 cal ²	5,1 psi	GF	6"	1,25"	1"	4	35 935,00

CAT/Claas 65/70/75/85/95 Prowadzenie GR 6" - Długość gąsienicy 336"											
24"x56x6" Leopard (GR 6")	24"	6"	2,25 -> 2,5"	1 712 cal ²	8,0 psi	GR	65"	1,25"	1"	4	28 900,00
30"x56x6" Leopard (GR 6")	30"	6"	2,25 -> 2,5"	2 121 cal ²	6,4 psi	GR	6"	1,25"	1"	4	37 965,00

AGCO/CAT Challenger seria MT700 Prowadzenie GS 6" - Długość gąsienicy 348"											
16"x58x6" Leopard HD (GS 6")	16"	6"	2,25 -> 2,5"	1 023 cal ²		GS	6"	1,75"	1,5"	5	23 372,00
18"x58x6" Leopard HD (GS 6")	18"	6"	2,25 -> 2,5"	1 140 cal ²		GS	6"	1,75"	1,5"	5	26 885,00
24"x58x6" Leopard HD (GS 6")	24"	6"	2,25 -> 2,5"	1 534 cal ²		GS	6"	1,75"	1,5"	5	31 606,00
30"x58x6" Leopard HD (GS 6")	30"	6"	2,25 -> 2,5"	1 901 cal ²		GS	6"	1,75"	1,5"	5	37 156,00

AGCO/CAT Challenger seria MT800 Prowadzenie GT 6" - Długość gąsienicy 396"											
30"x66x6" Leopard HD (GT 6")	30"	6"	2,25 -> 2,5"	2 360 cal ²		GT	6"	1,5"	1,25"	5	44 753,00
36"x66x6" Leopard HD (GT 6")	36"	6"	2,25 -> 2,5"	2 832 cal ²		GT	6"	1,5"	1,25"	5	52 612,00



Gąsienice Solideal serii Tiger



Rozmiar gąsienicy	Profil				Statyczny nacisk powierzchniowy	Prowadzenie		Karkas		Warstwy	Cena
	Szerokość	Element	Głębokość	Powierzchnia styku z podłożem		Typ	Element	Środek	Bok		
John Deere seria T8000 Prowadzenie GE 4,5" - Długość gąsienicy 324"											
25"x36x9" Tiger (GE 4,5")	25"	9"	2,5 -> 3"	1 246 cal ²	7,1 psi	GE	4,5"	1,5"	1,25"	5	29 941,00
30"x36x9" Tiger (GE 4,5")	30"	9"	2,5 -> 3"	1 495 cal ²	5,9 psi	GE	4,5"	1,5"	1,25"	5	35 935,00
John Deere seria T9000 Prowadzenie GQ 4,5" - Długość gąsienicy 378"											
30"x42x9" Tiger (GQ 4,5")	30"	9"	2,5 -> 3"	1 865 cal ²	7,5 psi	GQ	4,5"	1,5"	1,25"	5	41 930,00
CAT/Claas 35/45/55 Prowadzenie GF 4,5" - Długość gąsienicy 318"/320"											
25"x36x9" Tiger (GF 4,5")	25"	9"	2,5 -> 3"	1 204 cal ²	6,2 psi	GF	4,5"	1,5"	1,25"	5	29 108,00
30"x36x9" Tiger (GF 4,5")	30"	9"	2,5 -> 3"	1 445 cal ²	5,1 psi	GF	4,5"	1,5"	1,25"	5	34 945,00
CAT/Claas 65/70/75/85/95 Prowadzenie GR 4,5" - Długość gąsienicy 336"/338"											
25"x38x9" Tiger (GR 4,5")	25"	9"	2,5 -> 3"	1 499 cal ²	7,7 psi	GR	4,5"	1,5"	1,25"	5	31 606,00
30"x38x9" Tiger (GR 4,5")	30"	9"	2,5 -> 3"	1 799 cal ²	6,4 psi	GR	4,5"	1,5"	1,25"	5	37 937,00
AGCO/CAT Challenger seria MT700 Prowadzenie GS 4,5" - Długość gąsienicy 351"											
25"x39x9" Tiger HD (GS 4,5")	25"	9"	2,5 -> 3"	1 344 cal ²		GS	4,5"	1,75"	1,5"	6	34 103,00
30"x39x9" Tiger HD (GS 4,5")	30"	9"	2,5 -> 3"	1 630 cal ²		GS	4,5"	1,75"	1,5"	6	40 928,00
AGCO/CAT Challenger seria MT800 Prowadzenie GT 4,5" - Długość gąsienicy 396"											
30"x44x9" Tiger HD (GT 4,5")	30"	9"	2,5 -> 3"	1 984 cal ²		GT	4,5"	1,75"	1,5"	6	43 920,00



Rolki środkowe



Rozmiar rolki	Wymiary		Zalecana szerokość gąsienicy		Waga		Cena detaliczna [EUR netto/szt.]
	OD	Szerokość	Minimum	Maximum	lbs	kg	
JOHN DEERE T8000 - SERIES (12/tractor)							
14.6x4.5(12 1/2).(000)	14,6"	4,5"	16"	18"	33,1	15,0	324,00
14.6x8(12 1/2).(000)	14,6"	8"	24"	30"	59,5	27,0	390,00
14.6x9(12 1/2).(000)	14,6"	9"	25"	30"	66,1	30,0	409,00
JOHN DEERE T9000 - SERIES (16/tractor)							
14.6x8(12 1/2).(001)	14,6"	8"	30"	30"	59,5	27,0	390,00
14.06X10(12 1/2).(001)	14,6"	10"	36"	36"	74,9	34,0	427,00
CAT/Claas 35/45/55 (12/tractor)							
14x5.5(11 3/4).(000)	14"	5,5"	16"	18"	45,0	20,4	280,00
14x8.5(11 3/4).(000)	14"	8,5"	24"	30"	66,1	30,0	340,00
CAT/Claas 65/70/75/85/95 (16/tractor)							
14.6x8(12 1/2).(002)	14,6"	8"	24"	25"	59,5	27,0	375,00
14.6x9(12 1/2).(002)	14,6"	9"	25"	27,5"	66,1	30,0	390,00
14.6x10(12 1/2).(002)	14,6"	10"	30"	32,5"	74,9	34,0	405,00
AGCO/CAT Challenger MT700-series (12/tractor)							
14x5.5(11 3/4).(002)	14"	5,5"	16"	24"	45,0	20,4	279,00
14x8.5(11 3/4).(002)	14"	8,5"	24"	30"	66,1	30,0	334,00
14x10(11 3/4).(002)	14"	10"	25"	30"	77,8	35,3	362,00
AGCO/CAT Challenger MT800-series (16/tractor)							
14x5.5(11 3/4).(002)	14"	5,5"	16"	24"	45,0	20,4	279,00
14x8.5(11 3/4).(002)	14"	8,5"	24"	30"	66,1	30,0	334,00
14x10(11 3/4).(002)	14"	10"	30"	36"	77,8	35,3	362,00
CAT Lexion Harvester - Claas CIT Units (4/Unit)							
14x8.5(11 3/4).(001)	14"	8,5"	24"	30"	66,8	30,3	340,00
14x10(11 3/4).(001)	14"	10"	30"	36"	78,5	35,6	362,00

Uwaga: Ceny podane w EUR przeliczamy na PLN wg kursu sprzedaży EUR w banku NBP, z dnia wystawienia faktury.



Solideal felgi 4-elementowe



Rozmiar felgi	Ilość pierścieni	Rozmiar opony	Cena detaliczna zł netto/kpl.
Felgi do wózków widłowych marki Solideal (z pierścieniami)			
3.00 D - 8	3	4.00-8 / 5.00-8 / 15x4.5-8	512,00
4.33 R - 8	2	16x6-8 / 18x7-8	538,00
4.00 E - 9	3	6.00-9 / 140/55-9	596,00
6.00 E - 9	3	21x8-9	622,00
5.00 F - 10	3	6.50-10 / 7.50-10	699,00
6.50 F - 10	3	23x9-10 / 200/50-10	739,00
5.00 S - 12	3	7.00-12 / 8.25-12	893,00
8.00 G - 12	3	23x10-12 / 27x10-12	925,00
5.50 - 15	3	7.00-15 / 7.50-15 / 8.25-15	1 155,00
6.00 - 15	3	7.00-15 / 7.50-15 / 8.25-15	1 196,00
6.50 - 15	3	7.50-15 / 8.25-15 / 28x9-15	1 203,00
7.00 - 15	3	28x9-15 / 250-15	1 267,00
7.50 - 15	3	250-15	1 326,00
8.00 - 15	3	300-15	1 351,00
9.75 - 15	3	28x12.5-15 / 32x12.1-15	1 337,00
7.00 - 20	3	8.25-20 / 9.00-20 / 10.00-20	1 939,00
7.50 - 20	3	8.25-20 / 9.00-20 / 10.00-20	2 050,00
8.00 - 20	3	8.25-20 / 9.00-20 / 10.00-20	2 090,00

Wersja za dopłatą: Felgi bliźniacze + 30 %

Rozmiar obręczy	Ilość pierścieni	Rozmiar opony	Cena detaliczna zł netto/kpl.
Obręcze do wózków widłowych marki Solideal (z pierścieniami)			
3.00 D - 8	3	4.00-8 / 5.00-8 / 15x4.5-8	286,00
4.33 R - 8	2	16x6-8 / 18x7-8	315,00
4.00 E - 9	3	6.00-9 / 140/55-9	319,00
6.00 E - 9	3	21x8-9	349,00
5.00 F - 10	3	6.50-10 / 7.50-10	365,00
6.50 F - 10	3	23x9-10 / 200/50-10	412,00
5.00 S - 12	3	7.00-12 / 8.25-12	479,00
8.00 G - 12	3	23x10-12 / 27x10-12	512,00
5.50 - 15	3	7.00-15 / 7.50-15 / 8.25-15	486,00
6.00 - 15	3	7.00-15 / 7.50-15 / 8.25-15	530,00
6.50 - 15	3	7.50-15 / 8.25-15 / 28x9-15	567,00
7.00 - 15	3	28x9-15 / 250-15	651,00
7.50 - 15	3	250-15	727,00
8.00 - 15	3	300-15	760,00
9.75 - 15	3	28x12.5-15 / 32x12.1-15	781,00
7.00 - 20	3	8.25-20 / 9.00-20 / 10.00-20	1079,00
7.50 - 20	3	8.25-20 / 9.00-20 / 10.00-20	1235,00
8.00 - 20	3	8.25-20 / 9.00-20 / 10.00-20	1294,00

Uwaga: Powyższe tabele zawierają jedynie wybrane rozmiary felg z szerokiej gamy produktów. W celu otrzymania oferty na inny produkt, nie wymieniony powyżej, prosimy o kontakt z BOK tel. 22 783 35 89, biuro@solideal.com



Solideal — felgi typu Quick



Rozmiar felgi	Ilość pierścieni	Rozmiar opony	Cena detaliczna zł netto/kpl.
Felgi do wózków widłowych marki Solideal (bez pierścieni)			
3.00 D - 8		4.00-8 / 5.00-8 / 15x4.5-8	407,00
4.33 R - 8		16x6-8 / 18x7-8	428,00
4.00 E - 9		6.00-9 / 140/55-9	498,00
6.00 E - 9		21x8-9	523,00
5.00 F - 10		6.50-10 / 7.50-10	574,00
6.50 F - 10		23x9-10 / 200/50-10	611,00
5.00 S - 12		7.00-12 / 8.25-12	725,00
8.00 G - 12		23x10-12 / 27x10-12	775,00
5.50 - 15		7.00-15 / 7.50-15 / 8.25-15	935,00
6.00 - 15		7.00-15 / 7.50-15 / 8.25-15	973,00
6.50 - 15		7.50-15 / 8.25-15 / 28x9-15	994,00
7.00 - 15		28x9-15 / 250-15	1 035,00
7.50 - 15		250-15	1 052,00
8.00 - 15		300-15	1 068,00
9.75 - 15		28x12.5-15 / 32x12.1-15	1 101,00
7.00 - 20		8.25-20 / 9.00-20 / 10.00-20	1 582,00
7.50 - 20		8.25-20 / 9.00-20 / 10.00-20	1 652,00
8.00 - 20		8.25-20 / 9.00-20 / 10.00-20	1 677,00

Wersja za dopłatą: Felgi bliźniacze + 30 %

Rozmiar felgi	Ilość pierścieni	Rozmiar opony	Cena detaliczna zł netto/kpl.
Obręcze do wózków widłowych marki Solideal (bez pierścieni)			
3.00 D - 8		4.00-8 / 5.00-8 / 15x4.5-8	160,00
4.33 R - 8		16x6-8 / 18x7-8	185,00
4.00 E - 9		6.00-9 / 140/55-9	210,00
6.00 E - 9		21x8-9	235,00
5.00 F - 10		6.50-10 / 7.50-10	223,00
6.50 F - 10		23x9-10 / 200/50-10	265,00
5.00 S - 12		7.00-12 / 8.25-12	286,00
8.00 G - 12		23x10-12 / 27x10-12	344,00
5.50 - 15		7.00-15 / 7.50-15 / 8.25-15	344,00
6.00 - 15		7.00-15 / 7.50-15 / 8.25-15	375,00
6.50 - 15		7.50-15 / 8.25-15 / 28x9-15	395,00
7.00 - 15		28x9-15 / 250-15	420,00
7.50 - 15		250-15	445,00
8.00 - 15		300-15	470,00
9.75 - 15		28x12.5-15 / 32x12.1-15	525,00
7.00 - 20		8.25-20 / 9.00-20 / 10.00-20	781,00
7.50 - 20		8.25-20 / 9.00-20 / 10.00-20	916,00
8.00 - 20		8.25-20 / 9.00-20 / 10.00-20	966,00

Uwaga: Powyższe tabele zawierają jedynie wybrane rozmiary felg z szerokiej gamy produktów. W celu otrzymania oferty na inny produkt, nie wymieniony powyżej, prosimy o kontakt z BOK tel. 22 783 35 89, biuro@solideal.com



Pierścienie Solideal



Pierścień
uzupełniający



Pierścień
boczny



Pierścień
zaciskowy

Rozmiar obręczy	Ilość pierścieni	Rozmiar opony	Cena detaliczna zł netto/kpl.
Komplet pierścieni do felg			
3.00 D - 8	3	4.00-8 / 5.00-8 / 15x4.5-8	164,00
4.33 R - 8	2	16x6-8 / 18x7-8	147,00
4.00 E - 9	3	6.00-9 / 140/55-9	176,00
6.00 E - 9	3	21x8-9	176,00
5.00 F - 10	3	6.50-10 / 7.50-10	202,00
6.50 F - 10	3	23x9-10 / 200/50-10	202,00
5.00 S - 12	3	7.00-12 / 8.25-12	319,00
8.00 G - 12	3	23x10-12 / 27x10-12	319,00
5.50 - 15	3	7.00-15 / 7.50-15 / 8.25-15	428,00
6.00 - 15	3	7.00-15 / 7.50-15 / 8.25-15	428,00
6.50 - 15	3	7.50-15 / 8.25-15 / 28x9-15	428,00
7.00 - 15	3	28x9-15 / 250-15	428,00
7.50 - 15	3	250-15	559,00
8.00 - 15	3	300-15	559,00
9.75 - 15	3	28x12.5-15 / 32x12.1-15	428,00
7.00 - 20	3	8.25-20 / 9.00-20 / 10.00-20	613,00
7.50 - 20	3	8.25-20 / 9.00-20 / 10.00-20	613,00
8.00 - 20	3	8.25-20 / 9.00-20 / 10.00-20	613,00

Uwaga: Powyższe tabele zawierają jedynie wybrane rozmiary felg z szerokiej gamy produktów. W celu otrzymania oferty na inny produkt, nie wymieniony powyżej, prosimy o kontakt z BOK tel. 22 783 35 89, biuro@solideal.com, wraz z przesłaniem wypełnionej karty technicznej felgi.



Felgi skręcane (dzielone) do wózków widłowych

Rozmiar felgi	Rozmiar opony	Zastosowanie	Cena detaliczna zł netto
3.00 D - 8	4.00-8 5.00-8 15x4.5-8	Toyota, Mitsubishi Nissan, Catrepillar TCM, inne	173,00
4.00 E - 9	6.00-9 140/55-9		215,00
5.00 F - 10	6.50-10 7.50-10		263,00
5.00 S - 12	7.00-12 8.25-12		410,00



Felgi pierścieniowe do maszyn budowlanych

Rozmiar felgi	Ilość pierścieni	Rozmiar opony	Zastosowanie	Cena detaliczna zł netto
7.00-20 bliźniacza	2	8.25-20 9.00-20 10.00-20	Fuchs, Atlas, Doosan, Caterpillar, Volvo, JCB, CASE	1 473,00
7.50-20	1	31x10-20 33x12-20 36x14-20	inne	1 652,00
8.00TG-24 SDC	3	12.00-24 13.00-24 14.00-24	inne	3 245,00
10.00VA-24 SDC	3	13.00-24 14.00-24	inne	3 539,00
10.00-24 IRA	4	12.00-24 14.00-24	inne	5 389,87
14.00-25/1.5	3	17.00-25	inne	4 943,12
17.00-25/2.0	5	20.5-25	inne	6 624,90
19.50-25/2.5	5	23.5-25	HSW Ł-34 / HSW 534	4 515,00
19.50-25/2.5	5	23.5-25	inne	7 114,72
22.00-25/3.0	5	26.5-25	inne	8 192,88

Uwaga: Powyższe tabele zawierają jedynie wybrane rozmiary felg z szerokiej gamy produktów. W celu otrzymania oferty na inny produkt, nie wymieniony powyżej, prosimy o kontakt z BOK tel. 22 783 35 89, biuro@solideal.com, wraz z przesłaniem wypełnionej karty technicznej felgi.



Felgi tłoczone „drop center” do maszyn budowlanych



Rozmiar felgi	Rozmiar opony	Zastosowanie	Cena detaliczna z netto
10.50JA x 12	26x12-12	Kooiaap	620,00
8.25 x 16.5	10-16.5	Bobcat	651,00
8.25 x 16.5	10-16.5	inne	922,30
9.75 x 16.5	12-16.5	Bobcat	683,00
9.75 x 16.5	12-16.5 26x12-16.5 31.5x13-16.5	inne	1 000,12
9 x 18	12.5/80-18	Caterpillar, seria B / C / D	734,00
9 x 18	10.5-18 10.5/80-18 12.5/80-18	inne	966,43
11 x 18	12.5-18 12.5/80-18	inne	990,00
11 x 20	12.5-20 14.5-20	inne	1 072,50
13 x 20	405/70-20 16/70-20	inne	1 155,00
13 x 24	405/70-24 16/70-24 15.5/80-24 16.5/85-24	inne	1 387,00
W14L x 24	15.5/80-24 16.5/85-24 16.9-24 17.5L-24	inne	1 414,29
W15L x 24	16.5/85-24 16.9-24 17.5L-24	inne	1 437,86
DW16L x 26	18.4-26	Caterpillar, seria B / C / D	1 679,00
W15L x 28	16.9-28	Caterpillar, seria B / C / D	1 574,00
W15L x 28	16.9-28 18.4-28	inne	1 846,82

Uwaga: Powyższe tabele zawierają jedynie wybrane rozmiary felg z szerokiej gamy produktów. W celu otrzymania oferty na inny produkt, nie wymieniony powyżej prosimy o kontakt z BOK tel. 22 783 35 89, biuro@solideal.com, wraz z przesłaniem wypełnionej karty technicznej felgi.

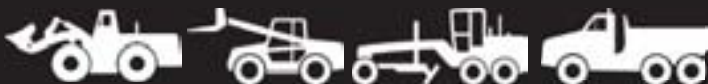
 ZAMÓWIENIE

 ZAPYTANIE

Symbol	Opis	Dane
D	Średnica otworu centralnego	mm
PCD	Średnica podziałowa otworów E1 na szpilki	mm
E1	Średnica nominalna otworów na szpilki	mm
E2	Średnica roztoczenia otworów na szpilki	mm
Ilość E1	Ilość otworów na szpilki <input type="checkbox"/> Symetryczne <input type="checkbox"/> Niesymetryczne	szt
ET	OFFSET	mm
S	Odległość krawędzi otworów na szpilki od krawędzi otworu centralnego	mm
G1	Odległość tarczy od krawędzi felgi od strony zewnętrznej	mm
G2	Odległość tarczy od krawędzi felgi od strony wewnętrznej (piasty)	mm
H	Grubość tarczy	mm
X	Wysokość otworu na wentyl	mm
Z	Szerokość otworu na wentyl	mm
RW	Szerokość felgi (osadzenia opony)	"
RD	Średnica felgi (osadzenia opony)	"
RZ	Szerokość zewnętrzna felgi	mm

INFORMACJA O MASZYNI:

marka:
 model:
 rok prod.:
 nr fabryczny

INFORMACJA O OPONIE:

marka:
 rozmiar:
 typ opony:
 superelastyczna (pełna)
 dętkowa bezdętkowa
 opaska "press-on"

Informacja o feldze: nr. katalogowy producenta maszyny
 nr zwa/nr katalogowy producenta felgi kolor

TYP FELGI: z 1 pierścieniem z 3 pierścieniami bez pierścieni typ "drop centre" (profilowana)
ROZMIAR: z 2 pierścieniami z 4 pierścieniami skręcana bliźniacza
RODZAJ TARCZY TYP/KSZTAŁT: prosta tłoczona typ

RODZAJ ZAFREZOWANIA OTWORÓW E2 POD SZPILKI

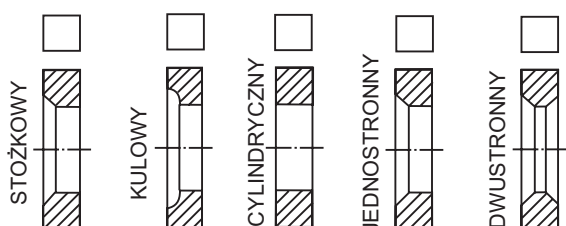

SPOSÓB MOCOWANIA FELG DO PIASTY ET (OFFSET)

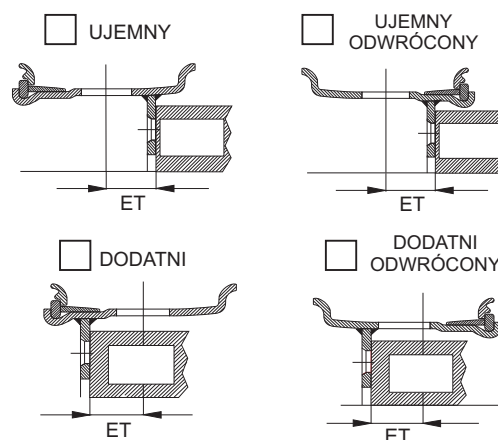

KONTAKT DO KLIENTA

Osoba kontaktowa:

Telefon:

e-mail:

pieczęć firmowa



PIASTA KOŁA

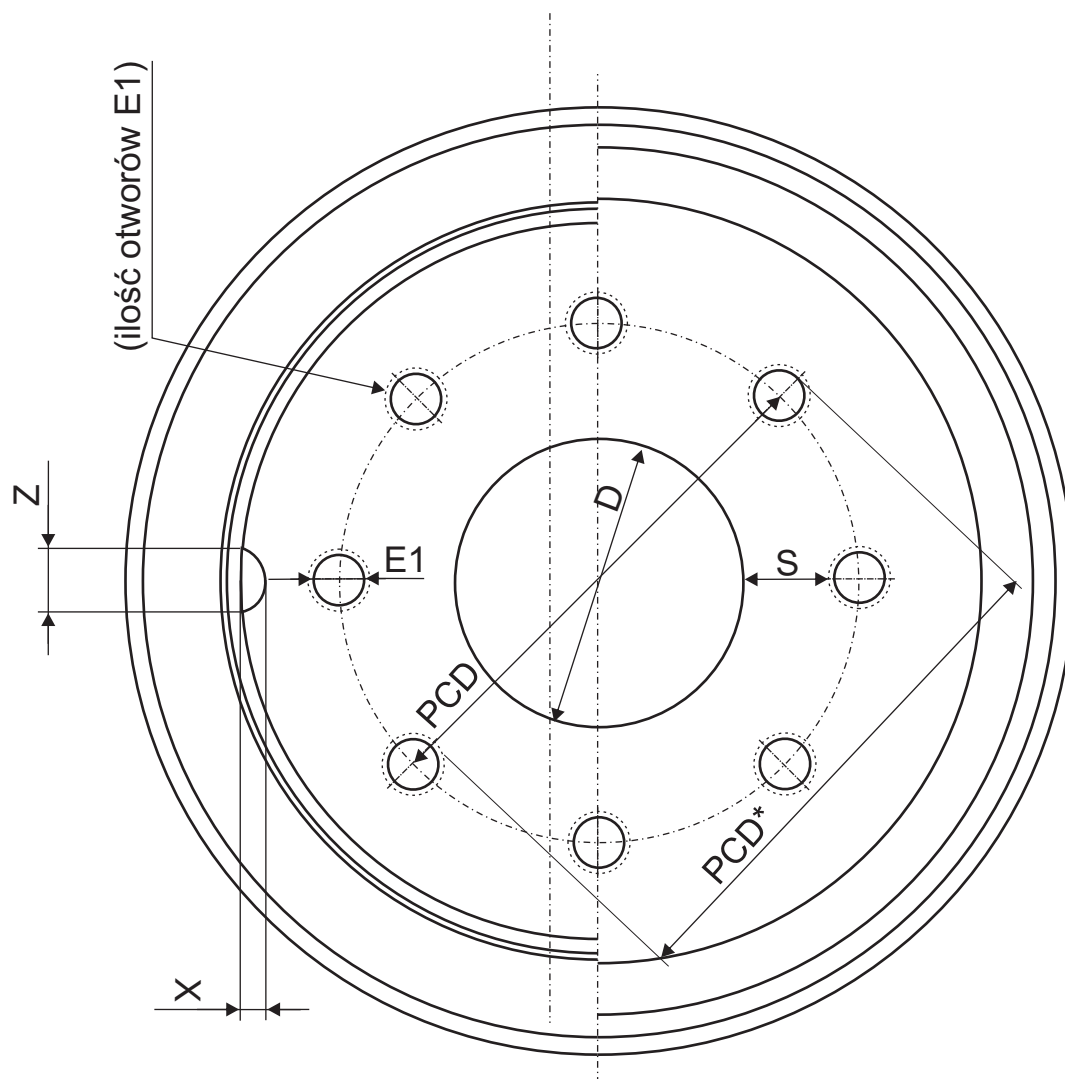
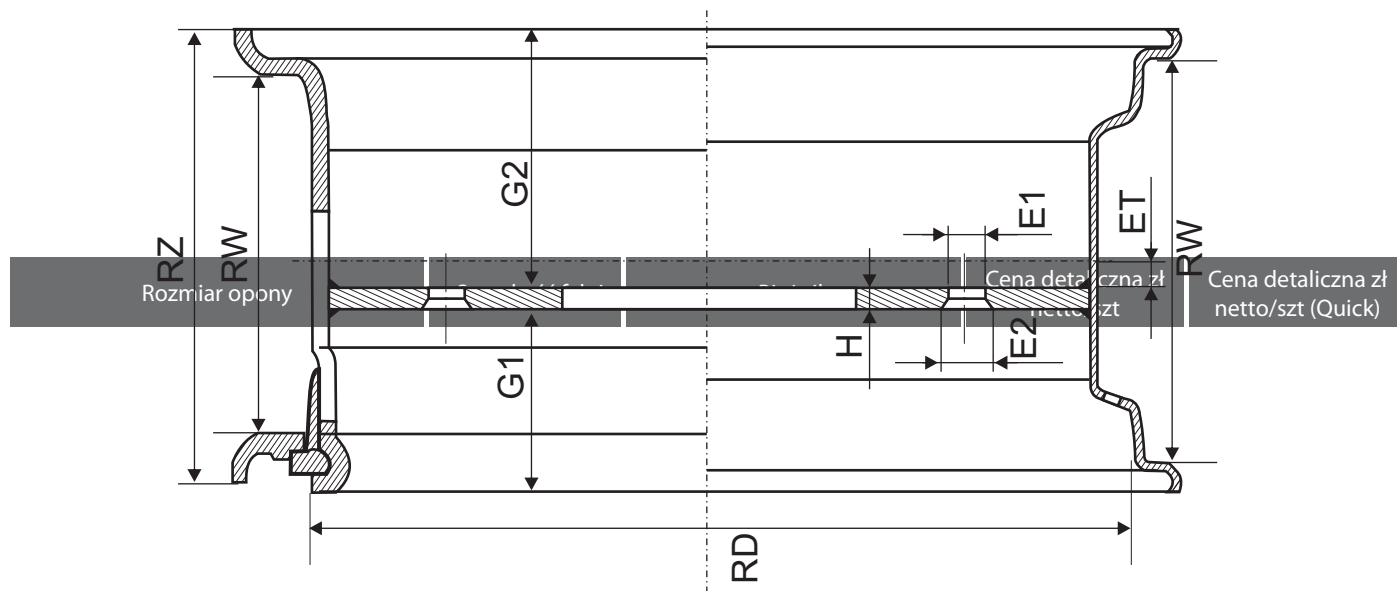

* dotyczy tylko felg z parzystą liczbą otworów na szpilki



Tarcza prosta



Typ 06



Typ 12

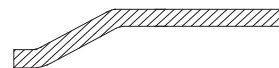

Typ 01/03

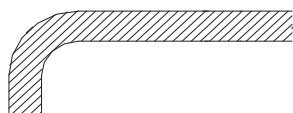

Typ 08

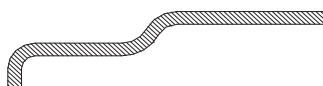

Typ 13

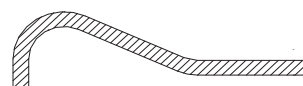

Typ 02

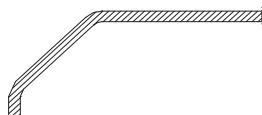

Typ 09

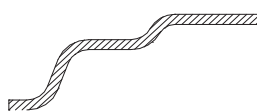

Typ 17

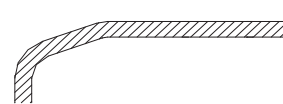

Typ 04

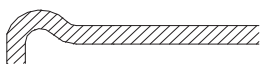

Typ 10

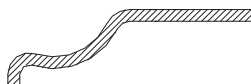

Typ 18

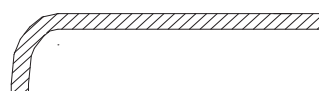

Typ 05

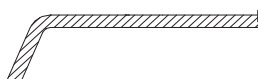

Typ 11



Typ 19

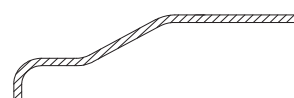

Wypełnienie opon elastomerem



Oferujemy Państwu usługę wypełnienia opon pneumatycznych elastomerem. W oponę, zamiast powietrza, wtłaczana jest dwuskładnikowa substancja, która po okresie zastygnięcia wypełnia wnętrze opony, eliminując przestoje związane z ubytkami powietrza podczas wykonywanych prac.

Zalety i charakterystyka wypełnienia opon elastomerem:

- Możliwość zastosowania we wszystkich typach i rozmiarach opon pneumatycznych.
- Właściwości amortyzowania porównywalne z oponami napełnianymi powietrzem.
- Pełna elastyczność w zakresie temperatur od – 40°C do + 120°C.
- Stałe ciśnienie wewnętrzne w oponie – nie wymagają przeglądów.
- Opona po wypełnieniu zachowuje pierwotny kształt i wymiar.
- Można użytkować przy stałych prędkościach nawet do 80 km/h.
- Dodatkowe cechy przy obciążeniu – wysoka pewność na postoju, lepsza przyczepność do podłoża.

Koszt wypełnienia zależy od pojemności opony. Informacje o pojemności danego rozmiaru opony oraz o koszcie wypełnienia udziela Biuro Obsługi Klienta, tel. 22 783 35 89.

Uszczelnienie opon



Uszczelnienie opon środkiem Liquifill marki Roesler – Zeus jest działaniem prewencyjnym, które zabezpiecza oponę przed ubytkiem powietrza podczas jej uszkodzenia szpiczastymi przedmiotami do wielkości 10 mm. Środek uszczelniający stanowi 2% objętości opony i jest stale w postaci płynu. Doskonale uszczelnia opony bezdętkowe od wewnątrz jak również nieszczelności przy stopce opony lub przy zaworze. Uszczelnienie opony można wykonać w dowolnym czasie i miejscu, bez konieczności demontażu koła z maszyny!

Uszczelniacz Liquifill		cena detaliczna zł netto / 1 kg		59,00
Pompka do uszczelniacza		cena detaliczna zł netto / 1 szt		435,00

Uszczelniacz oferujemy w opakowaniach 25 kg.

Informacji o pojemności danego rozmiaru opony udziela Biuro Obsługi Klienta, tel. 22 783 35 89

Cennik wypełnienia opon elastomerem

Pojemność opony (kg)	Cena netto (zł/kg)	Koszt demontażu i recyklingu (zł/szt)
≤ 5	80,00 (bez względu na ilość)	80,00
5 - 79	19,00	100,00
80 - 99	17,50	120,00
100 - 199	15,00	220,00
200 - 299	14,00	320,00
300 - 499	13,50	450,00
≥ 500	12,50	850,00

Jak obliczyć wartość wypełnienia.

Przykład:

405/70-20 (ok. 210 kg) x 4 szt = 210 kg x 14,00 zł x 4 szt = 11 760 zł

UWAGI:

- Do przygotowania oferty używamy zestawienia pojemności opon firmy RÖSLER – ZEUS – informacje dostępne telefonicznie w Dziale Sprzedaży SOLIDEAL POLSKA S.A.
- Są to wielkości przybliżone i jest możliwa tolerancja w ilości użytego elastomeru $\pm 10\%$. Jest to uzależnione od marki i rodzaju opony oraz profilu felgi.
- Do wypełnienia niezbędne jest:
 - stare koło do demontażu (jeśli było wypełniane),
 - lub felga; nowa opona,
 - w razie konieczności z dętką i ochraniaczem.
- Koło lub felgę oraz oponę klient dostarcza do Sulejówka.
- Dostawa wypełnionego koła na koszt klienta.

W razie konieczności indywidualnych ustaleń prosimy o kontakt z regionalnym doradcą techniczno-handlowym lub Biurem Obsługi Klienta tel. 22 783 35 89, 783 35 90, e-mail: biuro@solideal.com

Koszt transportu

Wartość zamówienia w zł	Dopłata w zł
do 500	45
do 1000	85
powyżej 1000	na koszt Solideal Polska S.A.

Uwaga: Istnieje możliwość odbioru osobistego lub zlecenie odbioru kurierowi, z którym klient ma podpisaną umowę.
Podany powyżej koszt transportu dotyczy zamówień produktów z grupy Solideal realizowanych z magazynu w Sulejówku.



PRASA STACJONARNA



PRASA MOBILNA

Montaż opon przemysłowych

SERWIS STACJONARNY						
L.p.	Nazwa Usługi	Rodzaj opony	Cena detaliczna zł netto/szt			
			wg średnicy felgi			
			8" - 9"	10" - 14"	15" - 19"	20" - 24"
1	MONTAŻ OPON ZAKUPIONYCH W FIRMIE SOLIDEAL	OPONY PNEUMATYCZNE	35,00	45,00	60,00	-
		OPONY PEŁNE	40,00	60,00	90,00	130,00
2	MONTAŻ OPON SPOZA FIRMY SOLIDEAL	OPONY PNEUMATYCZNE	55,00	75,00	100,00	-
		OPONY PEŁNE	80,00	110,00	200,00	300,00
3	DEMONTAŻ OPON (TYLKO DEMONTAŻ)	OPONY PNEUMATYCZNE	25,00	35,00	45,00	100,00
		OPONY PEŁNE	50,00	65,00	95,00	110,00

Przy montażu min. 8 szt. opon, stawka montażu w serwisie stacjonarnym podlega negocjacji.

SERWIS MOBILNY						
L.p.	Nazwa Usługi	Rodzaj opony	Cena detaliczna zł netto/szt			
			wg średnicy felgi			
			8" - 9"	10" - 14"	15" - 19"	20"
1	MONTAŻ OPON ZAKUPIONYCH W FIRMIE SOLIDEAL	OPONY PEŁNE	40,00	60,00	90,00	130,00
2	MONTAŻ OPON SPOZA FIRMY SOLIDEAL	OPONY PEŁNE	80,00	110,00	200,00	230,00
3	DEMONTAŻ OPON (TYLKO DEMONTAŻ)	OPONY PEŁNE	50,00	65,00	95,00	110,00

Przy montażu min. 8 szt. opon, stawka montażu w serwisie mobilnym podlega negocjacji.

Za dojazd serwisu do klienta pobierana jest dodatkowo opłata w wysokości 1,80 zł netto za każdy kilometr dojazdu i powrotu.

Do cen podanych powyżej należy doliczyć 22% VAT.

Cennik pras do montażu opon superelastycznych

Prasa mobilna PE120MS	
nacisk - 120 ton	
tłok wysuwany od góry	
możliwość montażu opon na felgi od 8" do 20" (20" po dokupieniu dodatkowego oprzyrządowania)	
Waga transportowa 2 000 kg	
Cena	22 555,00 Euro netto (prasa + oprzyrządowanie)*

Prasa mobilna PM100	
nacisk - 90 ton	
tłok wysuwany od góry	
możliwość montażu opon na felgi od 8" do 15"	
Waga transportowa 1 395 kg	
Cena	69 000,00 zł netto (prasa + oprzyrządowanie Eurowheel)
	59 000,00 zł netto (prasa + oprzyrządowanie Solideal)

Prasa stacjonarna PE120S	
nacisk - 120 ton	
tłok wysuwany od góry	
możliwość montażu opon na felgi od 8" do 20" (20" po dokupieniu dodatkowego oprzyrządowania)	
Cena	17 925,00 Euro netto (prasa + oprzyrządowanie)*

Prasa mobilna P100	
nacisk - 90 ton	
tłok wysuwany od góry	
możliwość montażu opon na felgi od 8" do 15"	
Cena	59 000,00 zł netto (prasa + oprzyrządowanie Eurowheel)
	49 000,00 zł netto (prasa + oprzyrządowanie Solideal)

* Płatność wg kursu sprzedaży Euro w NBP (tabela C) w dniu wystawienia faktury.

Procedura reklamacyjna



SOLIDEAL®

1. Zgłoszenia reklamacji należy dokonać pisemnie, na druku zgłoszenia reklamacji **SOLIDEAL POLSKA S.A.** w terminie do 30 dni od wykrycia wady (zgodnie z kartą gwarancyjną **SOLIDEAL POLSKA S.A.**).
2. Na zgłoszeniu muszą być wypełnione wszystkie pola dotyczące reklamowanego produktu.
3. Razem ze zgłoszeniem reklamujący powinien przesłać zdjęcia reklamowanego ogumienia, w dobrej jakości, ze szczególnym uwzględnieniem:
 - widoku bocznego i czołowego ogumienia;
 - marki;
 - rozmiaru;
 - NUMERU FABRYCZNEGO;
 - zgłaszanych uszkodzeń oraz stanu ogumienia (wyrwanie materiału) maksimum 5 zdjęć.
4. W przypadku niemożliwości wykonania zdjęć należy dostarczyć reklamacyjny produkt do **SOLIDEAL POLSKA S.A.**, na adres w 05-070 Sulejówku, ul. Hotelowa 4. Dostarczenie produktu odbywa się na koszt reklamującego.
5. W sytuacjach wątpliwych, co do oceny jakości produktu, **SOLIDEAL POLSKA S.A.** dopuszcza wykonanie wstępnej oceny i zebrania dokumentacji przez regionalnego Doradcę Techniczno-Handlowego, na miejscu u klienta.
6. O decyzji reklamacyjnej klient zostaje poinformowany w formie pisemnej w ciągu 45 dni od momentu dostarczenia materiałów oraz dokumentów.

Protokół reklamacyjny

Data zgłoszenia reklamacji przez użytkownika: _____

Data zgłoszenia reklamacji przez dystrybutora: _____

Numer reklamacji: _____

Reklamujący/pieczętka firmy:	Użytkownik / adres/pieczętka firmy:
------------------------------	-------------------------------------

Dane pojazdu	Marka : _____ Model: _____									
	Rok Produkcji: _____ Przebieg roczny w km _____ rbh _____									
	Rodzaj nawierzchni: <input type="checkbox"/> ziemia <input type="checkbox"/> piach <input type="checkbox"/> żwir <input type="checkbox"/> błoto <input type="checkbox"/> bruk <input type="checkbox"/> kostka bruk. <input type="checkbox"/> beton <input type="checkbox"/> asfalt <input type="checkbox"/> kamień inne _____									
	Ilość elementów napędowych: _____ Max. udźwig pojazdu: _____ Śr. prędkość pojazdu: _____									
	Prosimy zaznaczyć pozycję reklamowanej opony: <table style="width: 100%; border-collapse: collapse;"> <tr> <td style="width: 20%; text-align: center;">Oś / koło poz.</td> <td style="width: 20%; text-align: center;">P T</td> <td style="width: 20%; text-align: center;">P T</td> <td style="width: 20%; text-align: center;">P T</td> <td style="width: 20%; text-align: center;">P T</td> </tr> <tr> <td></td> <td style="text-align: center;"> </td> <td style="text-align: center;"> </td> <td style="text-align: center;"> </td> <td style="text-align: center;"> </td> </tr> </table>	Oś / koło poz.	P T	P T	P T	P T				
Oś / koło poz.	P T	P T	P T	P T						

Ogumienie	nr seryjny	rozmiar / bieżnik	ciśnienie ekspl.	przebieg w km	przebieg w rbh	pozostałość bieżnika	cykl pracy ilość zmian

Opis uszkodzenia ogumienia:

Data sprzedaży:

Nr faktury/paragonu:

Czy uszkodzenie opony spowodowało wypadek? TAK NIE

Żądanie w przypadku uznania reklamacji (wymiana na wolną od wad/zwrot gotówki).

W związku z wprowadzeniem globalnego systemu rozpatrywania reklamacji, w którym uczestniczy przedstawiciel biura technicznego i fabryki - termin rozpatrzenia reklamacji zgłoszonej formalnie wynosi 45 dni od dnia dostarczenia pełnej dokumentacji Ogumienie, które zostało przesłane przez Klienta wraz z protokołem reklamacyjnym, w przypadku odrzucenia reklamacji jest przechowywane przez 30 dni od daty wydania decyzji i w przypadku braku żądania zwrotu, jest po tym okresie przekazane do utylizacji.

Miejscowość :

Data:

Czytelny podpis użytkownika zgłaszającego reklamację:

Imię i Nazwisko	Adres e-mail	Telefon / Kontakt	
Dział Sprzedaży i Logistyki			
Agnieszka Tomaszewska	agnieszka.tomaszewska@solideal.com	tel. +48 22 783 35 90, 783 35 89, +48 22 783 17 87, 783 39 74, fax +48 22 783 35 82, e-mail; biuro@solideal.com	
Katarzyna Górecka	katarzyna.gorecka@solideal.com		
Beata Warzywoda	beata.warzywoda@solideal.com		
Monika Kąca	monika.kaca@solideal.com		
Dział Handlowy			
Krzysztof Polesiak	krzysztof.polesiak@solideal.com	+48 605 314 325	Region Centralno-Południowy , felgi
Grzegorz Szkulcecki	grzegorz.szkulcecki@solideal.com	+48 601 303 037	Region Centralno-Północno-Wschodni
Wojciech Szuba	wojciech.szuba@solideal.com	+48 693 802 908	Region Północno-Wschodni
Rafał Gryganiec	rafal.gryganiec@solideal.com	+48 691 605 301	Region Południowo-Zachodni
Robert Pawłowski	robert.pawlowski@solideal.com	+48 691 605 401	Region Północno-Zachodni

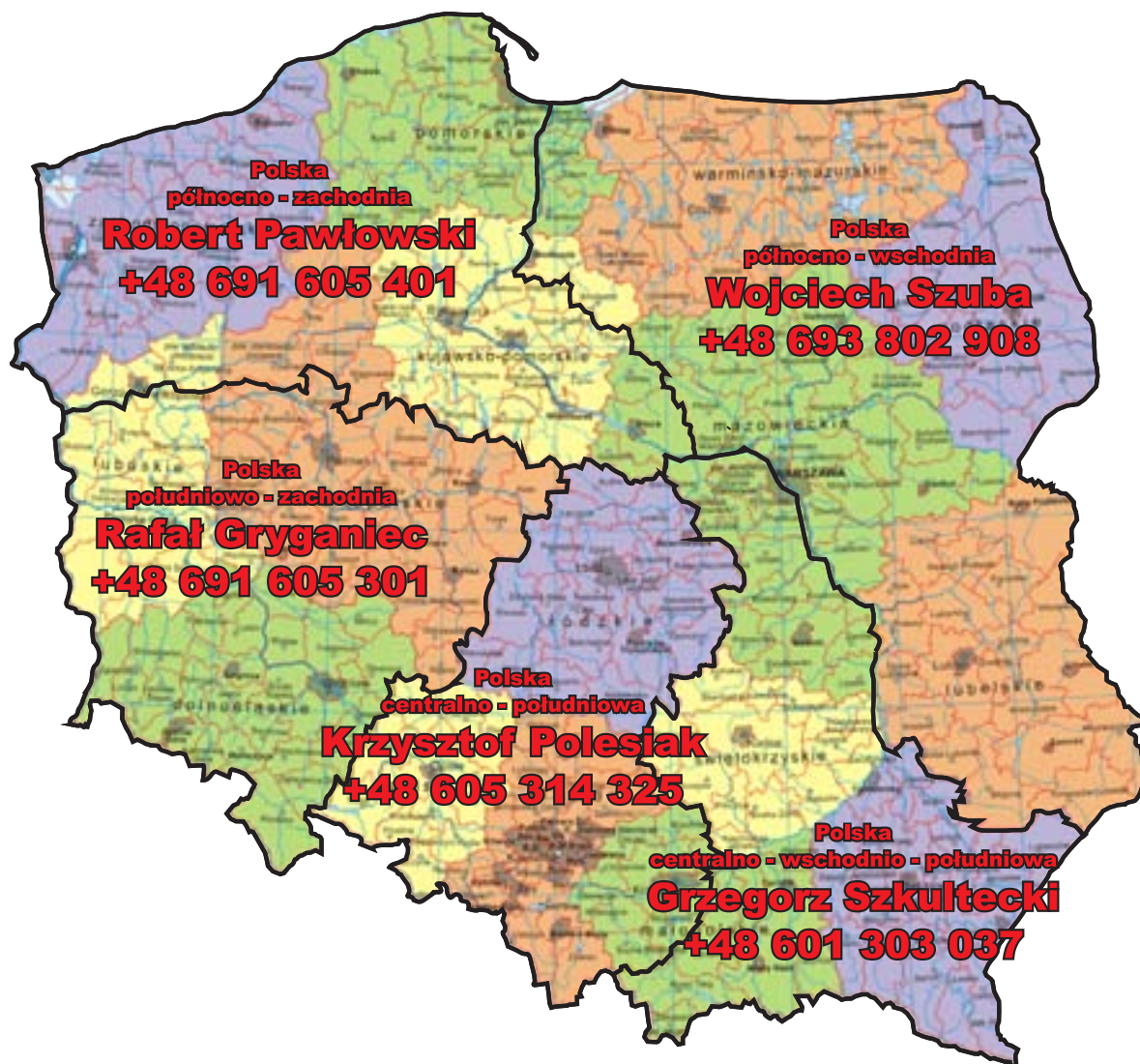



SOLIDEAL[®]

SOLIDEAL POLSKA S.A.

ul. Trakt Brzeski 35

05-077 Warszawa-Wesoła

tel.: +48 22 783 35 90, 783 35 89

fax: +48 22 783 35 82

biuro@solideal.com

solideal.pl